ELECRAFT K1 TRANSCEIVER



OWNER'S MANUAL



ELECRAFT K1

Multiband CW Transceiver

Owner's Manual

Revision I, April 15, 2011

Copyright © 2011 Elecraft, LLC
All Rights Reserved

Table of Contents

1. INTRODUCTION.....	3
2. SPECIFICATIONS	5
3. PREPARATION FOR ASSEMBLY.....	6
4. FILTER BOARD.....	11
5. FRONT PANEL BOARD.....	17
6. RF BOARD, PART I.....	25
7. ALIGNMENT AND TEST, PART I.....	36
8. RF BOARD, PART II.....	42
9. ALIGNMENT AND TEST, PART II.....	46
10. FINAL ASSEMBLY.....	48
11. OPERATION.....	50
12. CIRCUIT DETAILS.....	58
PARTS LIST.....	APPENDIX A
SCHEMATIC.....	APPENDIX B
BLOCK DIAGRAM.....	APPENDIX C
PHOTOGRAPHS.....	APPENDIX D
TROUBLESHOOTING.....	APPENDIX E
PARTS PLACEMENT DRAWINGS.....	APPENDIX F
QUICK REFERENCE.....	APPENDIX G

1. Introduction

The K1 is a versatile, low-power CW transceiver that covers two or four builder-selected HF bands. It provides 5 watts or more of power output; excellent receiver sensitivity and selectivity; and many useful operating features, including instant band selection, receive and transmit incremental tuning (RIT/XIT), digital display, configuration menu, and multiple crystal filter bandwidths.

With receive-mode current drain of about 55 mA, built-in keyer, and a stable, low-frequency VFO, the K1 is ideal for portable operation. It's also one of the smallest multi-band HF transceivers available—smaller than many single-band rigs. And, when used with the optional wide-range tilt stand (**KTS1**), the K1 is truly *trail-friendly*. The tilt stand comes with long arms for ground-mounting (see below), as well as shorter arms for desk-top use.



Like our all-band K2 transceiver, the K1 uses modular construction, allowing it to adapt to your operating needs. The Filter board covers either two (**KFL1-2**) or four (**KFL1-4**) bands, and a different Filter board can be swapped in at any time. There are two plug-in options, including a noise blanker (**KNB1**) and automatic antenna tuner (**KAT1**). There's also an internal AA-cell battery option (**KBT1**). These options can be installed easily at any time.

The K1's modular assembly will also appeal to first-time builders. The kit requires almost no point-to-point wiring, unlike earlier designs that used wiring harnesses. The K1 even provides its own built-in test equipment, including battery voltage monitor, wattmeter, and frequency counter. The manual provides complete troubleshooting and signal tracing procedures, and you'll find further support on our website, www.elecrafter.com.

We'd like to thank you for choosing the K1 transceiver, and hope it meets your expectations for operation both at home and in the field.

Wayne Burdick, N6KR
Eric Swartz, WA6HHQ

Customer Service Information

Technical Assistance

If you have difficulty with kit construction, operation, or troubleshooting, we're here to help. You may be able to save time by first consulting our web site, www.elecraft.com, or by posting your question on the Elecraft e-mail forum, elecraft@qth.net.

Telephone assistance is available from 9 A.M. to 5 P.M. Pacific time (weekdays only) at 831-763-4211. You can also send e-mail to support@elecraft.com. *Please use e-mail, rather than call, when possible since this gives us a written record of the details of your problem.*

Repair Service

If necessary, you may return your completed kit to us for repair. **Contact Elecraft before mailing your kit to obtain the repair shipping address, as well as information on repair fees.** (Kits that have been soldered using acid core solder, water-soluble flux solder, or other corrosive or conductive fluxes or solvents cannot be accepted for repair—see Warranty.)

The following information should be provided to expedite repair: your name, address, and phone number; your e-mail address (if applicable); and a complete description of the problem.

Shipping: First, seal the unit in a plastic bag to protect the finish from dust and abrasion. Use a sturdy packing carton with 3" or more of foam or shredded paper on all sides. Seal the package with reinforced tape. (Neither Elecraft nor the carrier will accept liability for damage due to improper packaging.) Cover the "to" address label with clear tape.

Elecraft's 1-Year Limited Warranty

This warranty is effective as of the date of first consumer purchase (or if shipped from factory, date product is shipped to customer). It covers both our kits and fully assembled products. For kits, before requesting warranty service, you should complete the assembly, carefully following all instructions in the manual.

Who is covered: This warranty covers the original owner of the Elecraft product as disclosed to Elecraft at the time of order. Elecraft products transferred by the purchaser to a third party, either by sale, gift or other method, who is not disclosed to Elecraft at the time of original order, are not covered by this warranty. If the Elecraft product is being bought indirectly for a third party, the third party's name and address must be provided to Elecraft at time of order to insure warranty coverage.

What is covered: During the first year after date of purchase, Elecraft will replace defective or missing parts free of charge (post-paid). We will also correct any malfunction to kits or assembled units caused by defective parts and materials. Purchaser pays inbound shipping to Elecraft for warranty repair, Elecraft will pay shipping to return the repaired equipment to you by UPS ground service or equivalent to the continental USA and Canada. Alaska, Hawaii and outside U.S. and Canada actual return shipping cost paid by owner.

What is not covered: This warranty does not cover correction of kit assembly errors. It also does not cover misalignment; repair of damage caused by misuse, negligence, or builder modifications; or any performance malfunctions involving non-Elecraft accessory equipment. The use of acid-core solder, water-soluble flux solder, or any corrosive or conductive flux or solvent will void this warranty in its entirety. Also not covered is reimbursement for loss of use, inconvenience, customer assembly or alignment time, or cost of unauthorized service.

Limitation of incidental or consequential damages: This warranty does not extend to non-Elecraft equipment or components used in conjunction with our products. Any such repair or replacement is the responsibility of the customer. Elecraft will not be liable for any special, indirect, incidental or consequential damages, including but not limited to any loss of business or profits.

2. Specifications

Measurements were made using a 14-V supply and 50-ohm load.

General

Size (H x W x D)	
Cabinet	2.2 x 5.2 x 5.6" (5.6 x 13 x 14 cm)
Overall	2.4 x 5.2 x 7.1" (6 x 13 x 18 cm)
Weight	1.4 lbs. (0.6 kg), excluding options
Supply voltage	8.5 to 15 VDC
Current drain	
Receive	55 mA typ. (no signal)
Transmit	700-900 mA typ. (5 W, 14 VDC)
Bands covered (MHz)	3.5, 7.0, 10.1, 14.0, 18.05, 21.0 (2 or 4 selected bands per module)
Frequency control	Electronically-tuned 3 MHz VFO; approx. 80 or 150 kHz range, selected during assembly
VFO drift	< 200 Hz per hour after 5-minute warm-up at 25° C
RIT/XIT range	Approx. +/- 3 kHz ¹
Display	3-digit LCD w/bargraph modes

Transmitter

Power output	0-5 watts or higher; spurious and harmonic content -40 dB @ 5 W
Load tolerance	2:1 or better SWR recommended; will survive high-SWR operation
Sidetone pitch	400-800 Hz in 10 Hz steps
Internal keyer	8-50 WPM; Iambic modes A and B; 2 message buffers; auto-repeat

Receiver

Sensitivity	Approx. 0.2 μ V for 10 dB (S+N)/N
I.F.	4.915 MHz, single conversion
Selectivity	4-pole variable-bandwidth crystal filter, approx. 200-800 Hz
Audio output	1 watt (peak) into 8-ohm load
Int. speaker	8 ohms, high-efficiency
Headphones or ext. speaker	8 ohms or higher; stereo plug (mono optional--see page 31, second assembly step)

¹ The RIT/XIT range can be easily modified; see page 55.

3. Preparation for Assembly

Overview of the K1

The K1 uses modular design for ease of assembly and troubleshooting. The chassis is made up of five pieces (Figure 3-1), any of which can be removed individually. The RF power amplifier transistor uses the right side panel as a heat sink, so there is no separate heat sink element. Each side panel includes a 10-32 threaded PEM nut as a mounting point for the KTS1 tilt stand.

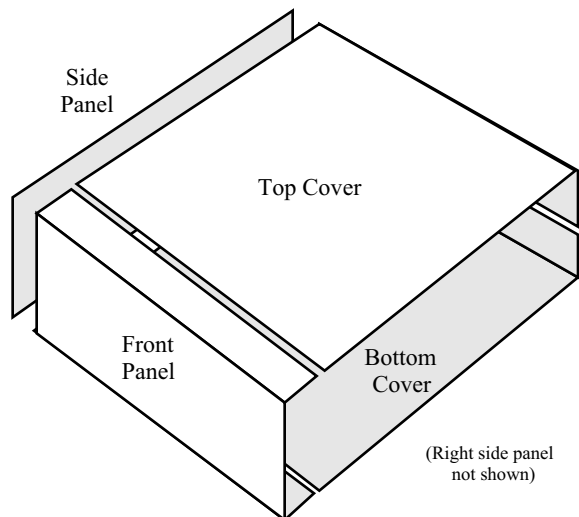

Figure 3-1

There are three printed circuit boards (PCBs), as shown in Figure 3-2: Front Panel board, Filter board, and RF board. These boards plug in together with no wiring, as explained in the next section. K1 options, such as the KNB1 noise blanker, also plug in directly. Appendix D shows photographs of each completed PC board assembly.

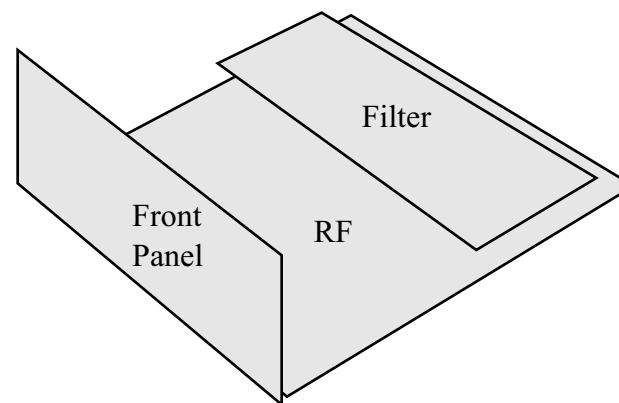

Figure 3-2

Board-to-board Connectors

The circuit boards in the K1 plug in together using *board-to-board* connectors, which eliminates nearly all hand wiring. Gold-plated contacts are used on these connectors for reliability and corrosion resistance.

Figure 3-3 shows a side view of the PC boards and board-to-board connectors. As can be seen in the drawing, the Front Panel board has a connector **J1** which mates with right-angle connector **P1** on the RF board. The Filter board has three connectors, **P1**, **P2** and **P3**, which mate with **J6**, **J7** and **J8** on the RF board.

These multi-pin connectors are difficult to remove once soldered in place. Refer to Figure 3-3 during assembly to make sure you have each connector placed correctly before soldering. If you install a multi-pin connector incorrectly, clip all of the pins at the body of the device first, remove all of the pins individually, and call us to request a new connector. You may damage pads and traces by trying to remove such components intact.

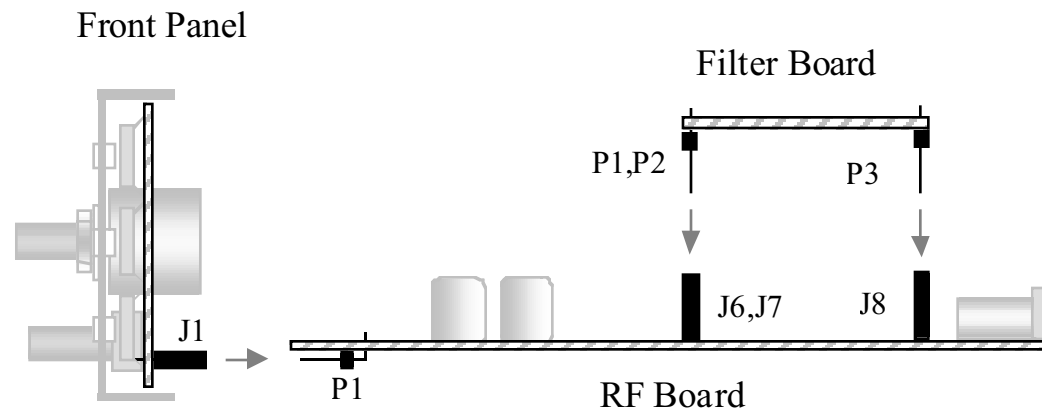

Figure 3-3

K1-2 (2-band version) and K1-4 (4-band version)

This manual covers all aspects of assembly for the two-band K1 (model K1-2). If you purchased a four-band K1 (model K1-4), you'll use the KFL1-4 assembly manual during assembly and alignment of the Filter board. You'll find instructions specific to the 4-band module at all appropriate places in this Owner's manual.

Unpacking and Inventory

Handling Integrated Circuits and Transistors

This kit uses integrated circuits (ICs) and transistors that can be damaged by electrostatic discharge (ESD). Problems caused by ESD can often be difficult to troubleshoot. To avoid this:

- Leave parts in their anti-static packaging until you install them
- Use an anti-static mat on your work bench
- Use a soldering iron with a grounded tip
- Ground yourself using a wrist strap with 1-Mohm series resistor
- At minimum, touch an unpainted, grounded metal surface before handling ESD-sensitive components

Inventory

We recommend that you do a complete inventory, using the parts lists in Appendix A. Start with the **K1 Packing Box** Parts list, which details the items you should find when you first open the box. Additional parts lists are provided for components used in each subassembly. Component photographs are provided in most cases.

Identifying Resistors and RF Chokes

Resistor and RF choke values and color bands are provided in the text. However, it's helpful to familiarize yourself with the color code. The color-code chart, Figure 3-4, shows how to read the four color bands on 5% resistors. For example, a 1,500 ohm (1.5 k) 5% resistor has color bands BROWN, GREEN, RED and GOLD.

1% resistors are similar, but use five bands: three significant digits, a multiplier, and tolerance. The first four bands on a 1.5 k, 1% resistor are BROWN, GREEN, BLACK, BROWN. The multiplier value is 1 rather than 2 in this case because of the third significant digit. *1% resistors have color bands that are sometimes hard to distinguish clearly; use an ohmmeter to identify them.*

The markings on RF chokes reflect their value in microhenries (μH), using two significant digits and a multiplier. Example: a choke with color bands RED, VIOLET, BLACK has value of 27 μH .

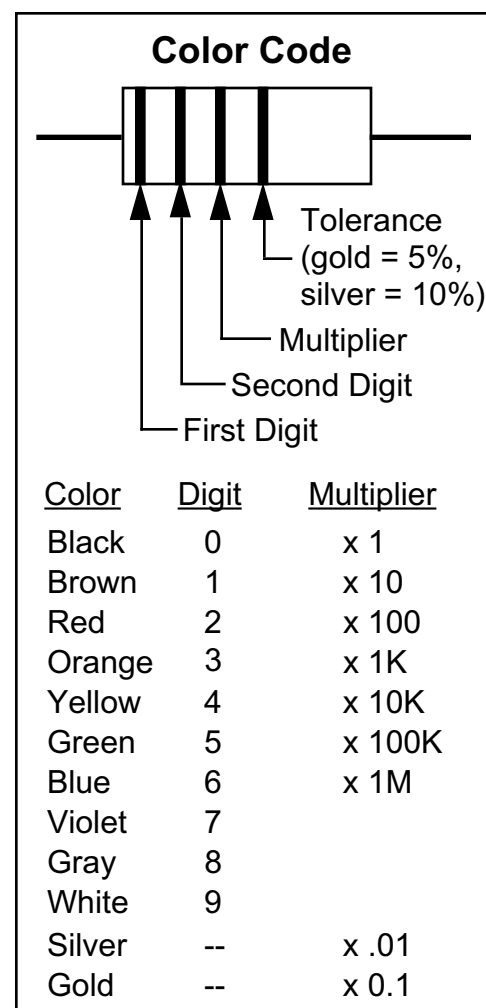

Figure 3-4

Identifying Capacitors

Small-value fixed capacitors are usually marked with one, two, or three digits and no decimal point. If one or two digits are used, that is the value in picofarads (pF). If there are three digits, the third digit is a multiplier. For example, a capacitor marked "151" would be 150 pF (15 with a multiplier of 10^1). Similarly, "330" would be 33 pF, and "102" would be 1000 pF (or .001 μ F). Exceptions are described specifically in the text and parts list.

Fixed capacitors with values of 1000 pF or higher often use a decimal point in the value, such as .001, .047, or 2.2. This is the value in *microfarads* (μ F). (1 μ F is equal to 1,000,000 pF.)

Tools

The following specialized tools are supplied with the K1:

- .050" (1.3 mm) and 5/64" (2 mm) Allen wrenches
- Double-ended plastic alignment tool

In addition to the tools supplied, you will need these standard tools:

- Temperature-controlled soldering iron, 700-800°F (370-430°C)
- Fine-point soldering iron tip, approx. .05" (spade type)
- Small-diameter, IC-grade solder (see Solder Recommendations)
- Desoldering tools (wick, solder-sucker, etc.)
- Needle-nose pliers
- Small-point diagonal cutters, preferably flush-cutting
- Small Phillips and flat-blade screwdrivers
- DMM (digital multimeter; do not use an analog VOM)
- Magnifying glass

We strongly recommend that you use a conductive wrist strap and anti-static mat during assembly. These items are available at very low cost from Jameco, Mouser, and other electronics suppliers.

Soldering and Desoldering

Use adequate ventilation when soldering, and avoid inhaling smoke or fumes. Always wash your hands after handling solder, as lead residue is highly toxic.

Solder Recommendations

We recommend small-diameter (.02 to .04") rosin-core solder, similar to Kester type 44. Solder with 2% silver is used by some builders and will work equally well. If you use a minimum of solder, there will be no need to clean PC boards. The use of acid-core solder, water-soluble flux solder, or any corrosive or conductive flux or solvent is likely to damage components and/or PC boards.

Soldering

When applying solder, use the *minimum* amount required to surround the component lead and make good contact with its printed-circuit pad. You don't need a "fillet" (build-up) of solder.

To provide a good connection, the solder must flow onto both the component lead and its PC board pad. To ensure that both will be heated at the same time, the tip of the iron should contact both the component lead and the PC board pad before solder is applied.

Solder joints should be *clean* and *shiny*. If a joint appears dull or has fine cracks, it is probably **cold**. Cold solder joints should be cleaned and re-soldered. First, use solder wick (desoldering braid) to remove the old solder. Then apply fresh solder. If you have many cold solder joints, it probably indicates that your soldering iron temperature is too low, or that the tip or solder itself is defective.

New soldering iron tips must be **tinned** before they're used. Allow the iron to warm up completely, then apply solder and allow it to coat the entire tip. After a few minutes, wipe off the excess solder. Use a sponge for wiping the iron tip, and clean the sponge often.

Desoldering

The printed circuit boards used in the kit are *double-sided*, meaning that they have circuitry on both sides. The component mounting holes are *plated-through* to complete electrical connections between the two sides.

Removing components from double-sided boards can be difficult, since you must get all of the solder back out of the hole before a lead can be removed. To do this, you'll need *solder wick* (desoldering braid) and/or a vacuum desoldering tool. It also takes some practice. A number of suggestions are provided below.

The best strategy for avoiding de-soldering is to place all components properly the first time. Double-check values and orientations, and avoid damaging parts via ESD.

When removing components:

- Don't pull a lead or pin out of a hole unless the solder has been removed, or you are applying heat. Otherwise, you can literally pull out the plating on the plated-through hole.
- Limit soldering iron contact to a few seconds at a time.
- Use small-size solder-wick, about 0.1" or 2.5 mm wide. Use the wick on both the top *and* bottom pads when possible. This helps get all of the solder out of the hole.
- If you use a vacuum desoldering tool (solder sucker), use a *large* unit. Small solder suckers are not very effective.
- The safest way to remove ICs and other components with more than 3 leads is to *clip all of the pins* at the body of the device first, then remove all of the pins *individually*. You may damage pads and traces by trying to remove such components intact.
- Invest in a PC board vice with a heavy base if possible. This makes parts removal easier because it frees up both hands.

If in doubt about a particular repair, ask for advice from Elecraft or from someone else with PCB repair experience.

Assembly Notes

Each step in the assembly process is accompanied by a check-box:



This symbol is used to alert you to important information:



Do not skip any steps. You may adversely affect both the performance and appearance of the kit by using the wrong assembly order.

Components

Sometimes we refer to components by their PC board and reference designator. For example, "FP-Q1" refers to transistor Q1 on the Front Panel board.

A few components in the kit are mounted on the bottom of PC boards. Component outline symbols are provided on the appropriate side of the board, so it will always be clear which side a particular component goes on. Bottom-mounted parts are also identified on the schematics by this symbol:



Photographs

Before beginning assembly, you should review the photographs in Appendix D to get an idea of what the completed PC boards look like. You'll also find front and back views of each PC board in the Parts Placement Drawings, Appendix F.

4. Filter Board

This section applies only to the two-band K1 Filter board. If you have a four-band K1, refer to the assembly instructions in the KFL1-4 manual.

The Filter board determines the K1's bands of operation. A photograph of the completed board appears in Appendix D.

- Open the bag of components labeled **KFL-2** and sort the parts into groups. Identify components using the photographs in the Filter board parts list in Appendix A.
- Locate the Filter printed circuit board (PCB), labeled "K1 FIL2" on one side.
- With the top side of the PC board facing you (notch at the lower right), locate the position of resistor R1, along the front edge. The label "R1" appears just left of the resistor's outline.
- Install a 100-ohm, 5% resistor (brown-black-brown) at R1, with its first color band (brown) toward the left. Make sure it is seated flat on the board, then bend the leads outward at about a 45-degree angle to hold it in place.
- Solder R1 on the bottom of the board. Trim the leads as close as possible to the solder joints.



Components may be soldered one at a time or in groups. Leads can be trimmed either before or after soldering.

- Install an 18-pin IC socket at U1, with the notched end of the socket oriented towards the "K1 FIL2" label. Bend two leads of the socket outward slightly to hold it in place while soldering. (U1 itself will be installed in a later step.)



In the following steps you'll install three relays (K1-K3). *Relay pins must not be bent*, even after placement on the PC board, as this may cause unreliable mechanical operation.

- Place relays K1-K3 on the top side of the board. One end of each relay has a heavy line printed across the top to indicate the pin 1 end. This end must be matched with the same end of the relay's PC board outline. Do not solder the relays yet.
- When all three relays have been placed on the board, lay a flat object such as a book or piece of cardboard on top of the relays to keep them in place, then flip the board over.
- Solder only two pins (at opposite corners) on each relay, using a minimum amount of solder. Limit soldering time to 2 or 3 seconds per pin. *Do not bend or trim the leads.*
- Turn the board back over and verify that all of the relays are in the correct orientation and are seated flat on the board. To check the orientation, refer to the Filter board drawing in Appendix F, at the bottom of the page.
- Solder all of the remaining relay pins. Do not bend or trim the leads.

Install the capacitors listed below. The list shows the capacitance value, followed by the labeling (in parentheses). After installing each capacitor, bend the leads outward at about a 45-degree angle to hold it in place until it is soldered and trimmed.

__ C29, .001 (102) __ C30, .001 (102) __ C27, .047 (473)

Place a bookmark at this page, and another at the **Per-Band Components** table in Appendix A.

Locate the two bags of *per-band* components, which are labeled by band, e.g. "40m" or "K1B40" (40 meters).

Under **Reference Designators** in the Per-Band Components table, there are **Band 1** and **Band 2** columns. Fill in the blanks at the top with your two bands (e.g., "40" and "20"). The lower-frequency band should be designated as **Band 1**.

Using strips of paper, or labels with a light adhesive such as "post-its," temporarily cover the band 2 reference designators column. Similarly, cover all of the components columns *except* the column associated with band 1. **This is a very important step that will eliminate possible confusion during assembly.**

Open the bag of components for band 1 only, setting the band 2 components aside for now.

 The leads on small capacitors may be pre-formed so that the capacitor sits slightly above the board when inserted; this will not affect performance. The leads are also somewhat fragile.

Install the capacitors for band 1, using the reference designators and values from the appropriate columns in the parts list. For example, if band 1 is 40 meters, install 390-pF capacitors at C1 and C5, then 330 pF capacitors at C2 and C4, etc. *Double-check each capacitor value as it is installed.* Do not solder yet.

Solder all of the band 1 capacitors.

At this point you'll need to choose whether to set up the VFO for 80-kHz or 150-kHz coverage (approx.). The smaller range covers the most-used portion of every band, provides smoother tuning, and is strongly recommended if you plan to upgrade to the four-band module (KFL1-4), which has narrower band-pass filters.

Record your VFO range selection here for reference:

__ 80 kHz __ 150 kHz

Note: Two different crystals are supplied for 30 meters, corresponding to two different lower band edges. Which one to use depends on your selected VFO range (see below). In the following steps you'll select one of the two crystals when applicable.

Band	VFO Range	Crystal	Band Edge
30 Meters	80 kHz	18.100	10.100
	150 kHz	18.000	10.000

If band 1 is 30 meters, select the appropriate crystal using the table above. Save the other crystal for possible future use.

Install the band 1 crystal at X1 on the filter board (*to the right of X2*), bending the leads to hold it in place. Make sure the crystal is seated correctly, then solder. Use a minimum amount of solder to avoid a short under the can.

Move the strips of paper or labels that you used earlier so that they cover the band 1 reference designators column, and all of the components columns except the column associated with band 2.

Open the components bag for band 2. Install the band 2 capacitors, using the reference designators and values from the appropriate columns as before. (Example: if band 2 is 20 meters, you'll install 180-pF capacitors at C6 and C10, etc.)

Locate the band 2 crystal and verify that it is the correct frequency. If band 2 is 30 meters, select one of the two crystals supplied (see table above). Install it at X2 and solder.

- Cut two 3/4" (19 mm) bare wires (use component leads).
- Referring to Figure 4-1, insert bare wires into the grounding holes provided near X1 and X2. Fold each wire over the top of the crystal and solder it on top. Keep soldering time below 5 seconds at a time; if it takes longer, your iron may not be hot enough, or your iron tip may not be making good contact with the crystal can. Solder and trim the wires on the bottom of the board.

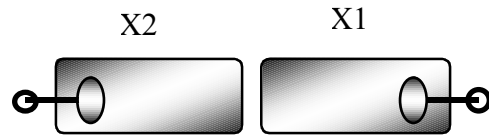

Figure 4-1

- Install the ceramic resonator, Z1, to the right of U1. (The ceramic resonator looks like a capacitor with three pins, and can be oriented in either direction.) *Limit soldering time to 2 or 3 seconds on each pin to avoid altering the oscillation frequency.*
- Locate the eight 1- μ H slug-tuned inductors, and make sure they are all have a red stripe or are labeled "T1050".
- Install the inductors at L1 through L8, pressing each one down as far as it will go. They have five pins, plus ground tabs, and can only be installed on the board one way. Solder the inductors.

- At the left and right ends of the board you'll find two short jumper locations, each labeled with a ground symbol (\perp). Use component leads to make 3/4" (19 mm) U-shaped wires for each jumper (Figure 4-2). Solder the jumpers on the bottom of the board, with the top of the U-shape approx. 1/4" (6 mm) above the board.



Figure 4-2

Identifying Toroid Cores

Several *toroidal inductors* are used in the K1, including four on the Filter board. It is important to use the correct type of core. This can be determined from the color and size.

The cores used on the Filter board are type T37-6. The *T* identifies an *iron-powder* core. The number following the *T* specifies the outside diameter in hundredths of an inch, in this case 0.37 inches (9.4 mm). The suffix (-6) refers to a specific mix of iron powder, which uses a particular color, in this case yellow.

Later in assembly you'll encounter *ferrite* cores, for example type FT50-43. In this part number, *FT* identifies the core as ferrite, and *50* is the size (0.50", 12.5 mm). The suffix (-43) identifies the type of ferrite used, although all ferrite cores are dark gray in color. All ferrite cores used in the K1 are of the -43 type.

 In the following steps you'll install toroidal inductors L9-L12 (type T37-6 cores). They must be wound as indicated in the instructions, or the transceiver will not operate correctly. *Use only the number of turns specified. It is not necessary to attempt to precisely match the inductances specified in the parts list.*

Find the component outline for L9 on the Filter board. Compare this component outline to Figure 4-3, which shows two views of a typical toroidal inductor. L9 will be mounted vertically as shown at the right side of the drawing, with one wire exiting at the core's upper left, and the other at the lower right. There are pads on the PC board in these two locations.

Using the Per-Band Components parts table (**Band 1**), determine the number of turns and wire length for L9 and L10.

To wind L9, cut the specified length of #26 red enamel-coated wire, then "sew" the long end of the wire through the core. *Each pass through the core counts as one turn.* The finished winding should look similar to Figure 4-3, but with the number of turns indicated in the parts list. *Figure 4-3 shows 14 turns.*

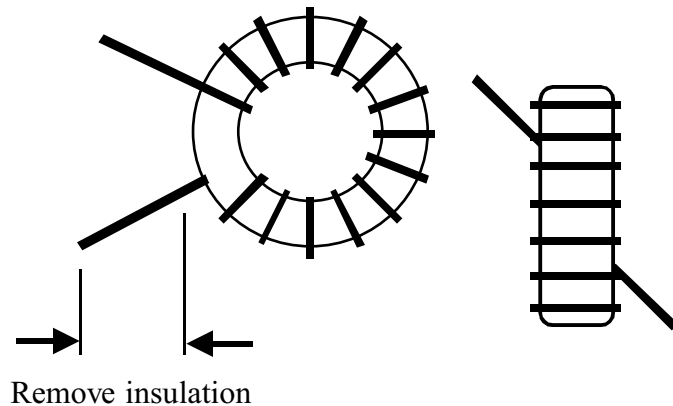

Figure 4-3

Verify that the turns of L9 are not bunched together. They should be evenly spaced, and should occupy about 80-90% of the core.

Stripping Toroid Leads

The enamel wire supplied with the kit can be heat-stripped. One way to do this is to place a small amount of solder (a "blob") on the end of your soldering iron, then insert the wire into the hot solder. If the iron is hot enough, you should see the insulation vaporize after 3 to 6 seconds. Another possibility is to burn the insulation off by heating it with a small butane lighter for a few seconds, then use fine-grain sandpaper to remove the enamel residue. Avoid scraping insulation off with a razor blade, as this may nick the wire.

Strip the leads of L9, as explained above. You should remove the enamel from the leads up to about 1/8" (3 mm) from the core (Figure 4-3).

Tin L9's leads. The solder should appear clean and shiny. If it looks dull or is not adhering very well to the bare lead, there is probably some insulation remaining. Remove it as described above.

Install L9 vertically as shown by its component outline. Pull the leads taut on the bottom of the board.

Solder the leads of L9. When soldering, make sure that the solder binds well to the leads. If the lead appears to be an "island" in a small pool of solder, chances are it is not making good contact.

Wind and install L10 in the same manner as L9, using the same number of turns. Install L10 vertically, to the right of L9.

Wind and install L11 and L12. Use the Per-Band Components table (**Band 2**) to look up the wire length and number of turns.

 Do not use adhesives or fixatives of any kind to secure L9-L12 to the PC board. They will be adequately held to the board by their leads alone.

 **The connectors to be installed in the following steps must be positioned correctly to avoid intermittent or unreliable operation.**

Before attempting to install multi-pin connectors, review the information on page 7.

Install an 8-pin male connector (plug) at P1, but do not solder yet. Figure 4-4 shows P1 as viewed from the left end of the Filter board. The plastic part of the connector must be on the bottom side of the board, with the long end of the pins pointed down. The short pins are inserted into the board.

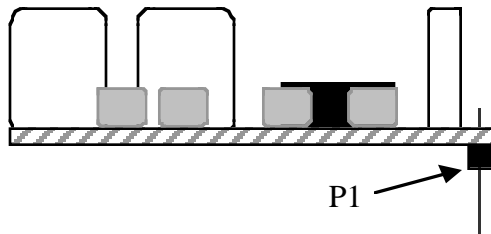

Figure 4-4

Solder just one of the middle pins of P1, on the top side.
Note: multi-pin connectors have plastic bodies that can melt if too much heat is applied, causing the pins to be mis-positioned. Limit soldering time for each pin to 2 to 3 seconds.

Examine the placement of P1 closely. If it is tilted or is not flat against the board, re-heat the solder while pressing down on the connector.

Once P1 is in the right position, solder the remaining pins. Do not trim the leads.

Install P2 and P3 in the same manner as P1. Before soldering, verify that each connector is flat against the board and not tilted.

Cut a 1" (25 mm) length of insulated hookup wire. Strip about 1/8" (3 mm) of insulation off of each end.

Install this wire between pins 2 and 10 of J2, in the upper right-hand corner of the board (Figure 4-5). The pins on J2 are counted from left to right and top to bottom as shown.

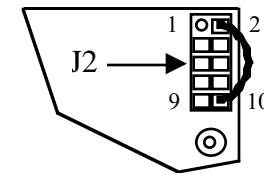



Figure 4-5

 Before handling U1 in the next step, touch an unpainted, grounded metal surface.

Straighten the leads of U1 (PIC16C620) as shown in Figure 4-6. The two rows of pins must be straight and parallel to each other to establish the proper pin spacing. To straighten the pins, rest one entire row of pins against a hard, flat surface. Press down gently on the other row of pins and rock the IC forward to bend the pins into position as shown below.

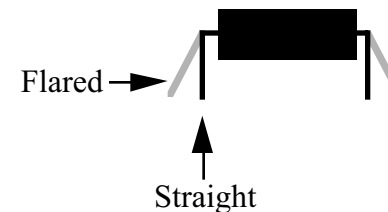

Figure 4-6

- Insert U1 into its socket, with the notched or dimpled end of the IC aligned with the notched end of the PC board outline. Figure 4-7 shows an 8-pin IC; U1 is similar but has 18 pins.) Press U1 down into the socket as far as it will go.

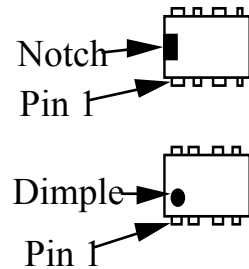

Figure 4-7

Note: IC pins are counted by going around the IC counter-clockwise from pin 1.

- Examine U1 closely. If any pins are bent, remove the IC and straighten them. (To remove U1 from its socket, pry it up gently on each end using a small flat-blade screwdriver.)
- Locate the blank white area near U1. This area is provided for labeling the Filter board with the two bands covered (e.g. "40, 20"). Use an indelible marker, dry transfers, or an adhesive label.

Uninstalled Components

All component locations on the Filter board should now be filled except J1 and J2, which are provided for the automatic antenna tuner (KAT1). The KAT1 option should be installed only after the basic K1 kit has been completed and tested. At that time, the jumper you installed between pins 2 and 10 of J2 will be removed. If you're building a 2-band Filter board that includes 80 meters, you'll have a 10 μ F electrolytic capacitor left over at this point. This will be installed on the RF board at C78 in a later step.

Visual Inspection

- Using the parts placement drawings in Appendix F, re-check the orientation of the relays (K1, K2, K3) and U1.



About 90% of all problems with kits are caused by poorly-soldered component leads. Such problems can be avoided by doing a careful inspection of the board, preferably with a magnifying glass.

- Examine the bottom of the PC board closely for cold solder joints, solder bridges, and unsoldered components.

Resistance Checks

- Make the measurements listed below, touching the meter's (+) and (-) leads to the indicated points. Measurements at relay K3 must be made on the bottom side. Relay pins are numbered like ICs, with pin 1 identified by its round pad. The Filter board schematic (in Appendix B) may help you troubleshoot any incorrect readings.



The symbol > means *greater than*, and < means *less than*. Your DMM may indicate infinite resistance (all digits flashing) for readings that are listed as "> 100 k." (Do not use an analog VOM.)

Test Points (+, -)	Resistance
U1 pin 6, U1 pin 7	230-270 ohms
U1 pin 6, U1 pin 8	230-270 ohms
U1 pin 6, U1 pin 12	230-270 ohms
U1 pin 13, P2 pin 6	90-110 ohms
P1 pin 1, P1 pin 3	> 100 k
P1 pin 2, P1 pin 3	> 100 k
P1 pin 3, P1 pin 4	> 100 k
P1 pin 3, P1 pin 6	> 100 k
P2 pin 1, P2 pin 2	> 100 k
P2 pin 7, P2 pin 8	> 100 k
K3 pin 2, K3 pin 9	< 5 ohms
K3 pin 4, K3 pin 7	< 5 ohms

5. Front Panel Board

The liquid-crystal display (LCD), switches, and other controls are located on the Front Panel board, as well as the microcontroller. See Appendix D for photos of the completed assembly.

- Open the bag labeled **FRONT PANEL** and sort the parts into groups. Observe anti-static precautions with ICs and transistors.
- Locate the front panel PC board, which is labeled "K1 FP" along one edge. In the steps that follow, we will refer to the side with the switches and LCD (S1-S6 and DS1) as the *top* side.
- Place the board in front of you with the bottom side up. Locate the component outline for J1, below the large hole.
- Install a 20-pin female connector (receptacle) at J1 as shown in Figure 5-1. Do not solder yet.

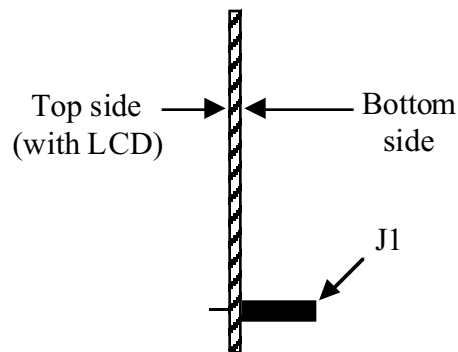

Figure 5-1

- Solder one pin of J1 on the top side, near the middle of the connector. If J1 is not seated flat against the PC board or is tilted, re-heat the solder and press down on the connector.
- Once you're sure that J1 is correctly installed, solder the remaining pins. Do not use an excessive amount of solder.
- Locate the **Switch Spacing Tool** (made of PC board material).
- Position push-button switch S1 on the top side of the board as shown in Figure 5-2, using the switch spacing tool to set the switch height. Make sure all four legs of the switch are centered in their holes, then gently push the switch until it is resting flush against the switch-spacing tool. (Caution: switch pins are fragile.) *Do not solder yet.*

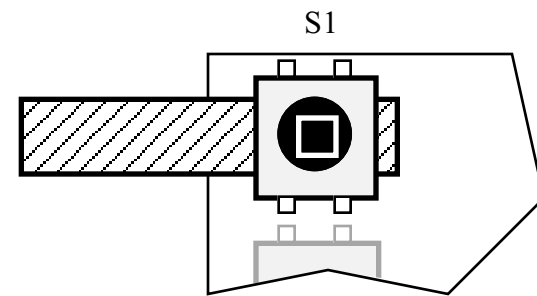

Figure 5-2

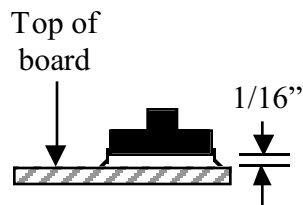

Figure 5-3

Figure 5-3 shows a side view of a switch that is properly mounted (spacing tool not shown). The leads of the switches will just be visible on the bottom of the board. *Proper switch height is important for maintaining an even appearance.*

Once S1 is seated correctly, solder the leads on the bottom side of the board. Leave the spacing tool in place while soldering.

Install S3, once again using the switch spacing tool to adjust the switch height. When soldering S3, be careful not to contact the plastic body of J1 with the soldering iron.

Install switches S2, S4, S5, and S6 using the same technique. Note: Switch caps will be installed later.

Install these parts on the top side of the board. Solder them on the bottom side, using a minimum of solder.

__ R8, 22 (RED-RED-BLK) __ C4, .047 μ F (473)

Trim the leads of R8 and C4 as close to the board as possible so that they won't interfere with the 40-pin IC socket (next step).

Install the 40-pin IC socket at U1, on the bottom side of the board. The board is labeled "SOCKET" at this location. Orient the socket's notched end to the left (the pin 1 end). To hold the socket in place, bend pins 1 and 21 outward slightly; these two pins are diagonally opposite. Solder only these two pins.

If the socket does not appear to be seated flat on the PC board, reheat these two pins while pressing on the socket. If the leads of C4 hit the socket, trim them closer to the board.

Solder the remaining pins of U1. (U1 itself will be installed in the socket in a later step.)

Install and solder the following components. When soldering components near the push-button switches, be careful not to touch the switches with the soldering iron.

Top side:

__ R4 and __ R5, 10 k (BRN-BLK-ORG)
__ R11, 100 k (BRN-BLK-YEL)

Bottom side:

__ R6, 12.7 k, 1% (BRN-RED-VIO-RED)
__ R7, 3.92 k, 1% (ORG-WHT-RED-BRN)
__ R9, __ R10, and __ R19, 100 k (BRN-BLK-YEL)
__ R13, 470 (YEL-VIO-BRN)
__ R12, 2.7 k (RED-VIO-RED)
__ R14 and __ R15, 1 k (BRN-BLK-RED)
__ R16, 2.7 k (RED-VIO-RED)
__ C5 and __ C6, .01 μ F (103)

Install capacitors C1 and C2 (82 pF), near U1.

Locate resistor network RP1. ("RP" means "resistor pack," another name for resistor networks.) One end of RP1 has a band or dot, indicating pin 1. RP1 should be labeled 77083102, 83C102, or 8A3102G. If the labeling differs, verify the resistance. You should measure about 1.0 k between each pair of adjacent pins.

Install RP1 on the bottom side of the board. The end with a dot or bar should be oriented towards pin 1 of the PCB outline. When soldering RP1, keep the iron tip away from S4 and S5.

Install and solder the two 82- μ H RF chokes, RFC1 and RFC2 (GRAY-RED-BLK).



Before handling ICs and transistors in the following steps, touch an unpainted, grounded metal surface.

□ Locate transistor Q1 (type 2N4124), which has a small, 3-lead TO-92 package. Q1 and other TO-92 devices may have either of the two shapes shown in Figure 5-4. The right-hand illustration shows a "modified TO-92" package, which may be labeled on either the front or back side. The large flat side of each device will be aligned with the flat side of its component outline.

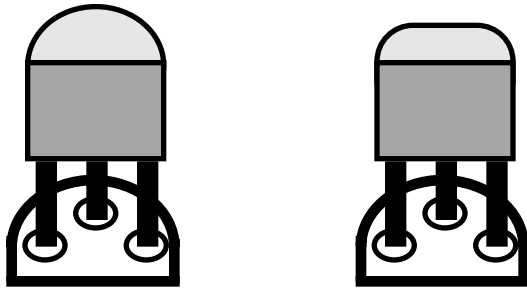

Figure 5-4

□ Install Q1 on the bottom side of the board, to the right of the large hole. Align Q1 as shown above. The transistor should be mounted about 1/8" (3 mm) above the board; don't force it down too far or you may break the leads. Bend the leads outward slightly to hold Q1 in place, then solder and trim the leads.



□ Locate U4, a 78L06 voltage regulator, which has a TO-92 package similar to Q1. Install U4 below the large hole.



Touch an unpainted, grounded metal surface before handling the 2N7000 transistor in the next two steps.

□ Locate the component outline for Q2 (2N7000) on the top side of the board near the rectangular hole. Q2's outline has the three pins side-by-side, not in a triangular pattern. Pre-form the leads of Q2 to match this hole pattern, so that it can be mounted very close to the PC board with little excess lead length.

□ Install Q2. **Make sure the top of Q2's body is no more than 0.25" (6 mm) above the board when seated.** Solder Q2.

□ Install the 8-pin ICs, U2 (MAX518), U3 (24LC04), and U5 (LM358) on the bottom side. Orient the notched or dimpled end of each IC with the notched end of its component outline (see Figure 4-7). Bend two leads outward slightly on the opposite side of the board to hold the devices in place, but do not solder yet.

□ Turn to Appendix F (parts placement drawings) to verify that you have the ICs installed in the proper locations, then solder. Limit soldering time to 2 to 3 seconds on each lead.

□ On the top side of the board at the left end you'll find a short jumper location, labeled with a ground symbol (\perp). Install a 3/4" (19 mm) U-shaped wire here, as you did earlier on the Filter board.



The potentiometers to be installed in the next step can be damaged if you push on their plastic shafts. When seating a potentiometer, press down only on the metal frame.

□ Install the two 10-k potentiometers at R2 and R3 (on the top side of the board). They must be pressed downward until the metal frame is fully contacting the PC board on both sides. Do not use excessive heat when soldering.

Open the bag labeled **MISCELLANEOUS** and empty the contents into a shallow box or pan. This will prevent loss of any of the small hardware while allowing you to locate items as needed.



Five sizes of 4-40 screws are used. All are black anodized except the 1/4" and 3/8" pan heads (see Figure 5-5). The length of flat-head screw is measured from the top of the head.

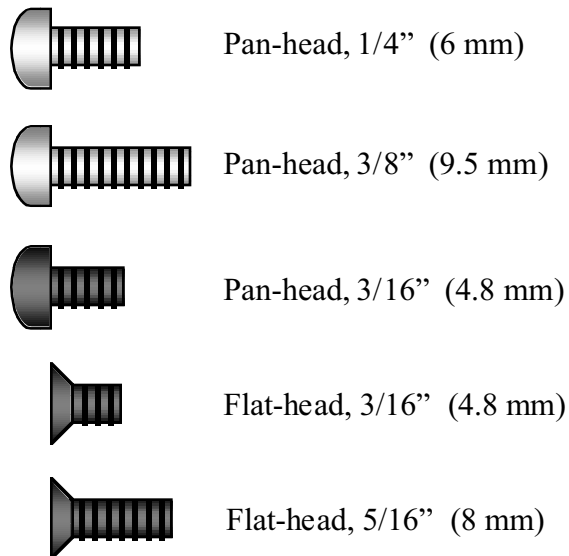

Figure 5-5

- Identify all of the 4-40 screws and sort them into groups.
- Install a 3/16" (4.8 mm) diameter x 1/4" (6.4 mm) long round standoff on the top of the board (Figure 5-6). The hole for this standoff is just below the large hole. Use *two* #4 split lock washers and a 1/4" (6 mm) pan-head screw (not black anodized) as shown. Insert the lock washers between the standoff and PC board.

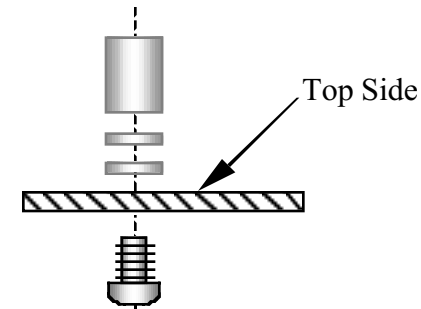

Figure 5-6

- Install crystal X1, near C1 and C2 on the bottom of the board.
- To the right of X1 you'll find a ground pad for the crystal can. Use a discarded component lead to make the grounding wire, as shown in Figure 4-1 (page 13).
- Locate LEDs D1 and D2, which are identical in size but have different-colored bodies. D1 has a clear diffuse body, while D2 has a yellow tint. Near the point where the leads exit the body, you'll find a flat side in the plastic, which identifies the cathode lead.
- Install D1 (clear diffuse body) on the top side of the board, with its flat side aligned with the flat side of the component outline. (This is the side nearest the square pad.) Position D1 about 1/16" (1.5 mm) above the board. You can use the switch-spacing tool, a toothpick, or short length of insulated hookup wire to maintain the proper spacing while soldering.
- Verify the orientation of D1's flat side, then solder.
- Install and solder D2 using the same method.

- Inspect the solder side of U1's socket on the top side of the board. Make sure all pins are soldered, with no cold solder joints.
- Using a DMM, check every pair of adjacent pads on U1 on the top side of the board (pins 1-20 and 21-40). The resistance between pads should be over 1000 ohms (1 k) in all cases, and may read *infinite* on your DMM (often indicated by a flashing display).



Before handling U1 in the next step, touch an unpainted, grounded metal surface.

- Straighten the pins of the microcontroller, U1. You can hold the IC body at the ends as you re-form each row of pins.
- Insert U1 into its socket, with the notched end oriented towards the pin 1 end of the component outline.
- Look at both rows of pins on U1 closely. If any pins are bent, carefully remove the IC by prying at both ends using a small flat-blade screwdriver. Straighten the pins using long-nose pliers.

NOTE: If you purchased the K1 LCD Backlight Kit and are going to install it into your K1 now, refer to the instructions for adding the backlight, then go directly to Visual Inspection on the next page.

- Locate the black neoprene LCD spacer (MISC. bag), which is 1/2 x 1/2 square and 3/16" thick (12 x 12 x 5 mm). Remove the adhesive backing from one side and position the spacer as shown in Figure 5-7. It must be mounted flat against the PC board, centered between the two rows of pins on U1's socket.

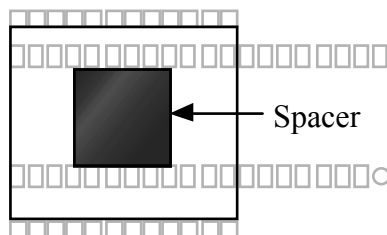

Figure 5-7



Caution: the LCD (DS1) and its pins are fragile.

- Remove the LCD from its packing materials, being careful not to bend the pins. As shown in Figure 5-8, the pin 1 end of the LCD glass has a very slight bump, along with a break in the black border. This end will be oriented towards the pin 1 end of DS1's component outline.

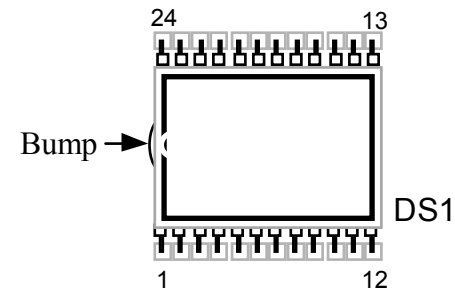

Figure 5-8

- Remove the adhesive backing from top side of the LCD spacer.
- Install the LCD at DS1, oriented as shown above. Make sure that all 24 pins are inserted into their holes, then press down gently on the LCD to secure it to the LCD spacer's adhesive surface. The LCD pins may not extend all the way through the holes. The surface of the LCD must be parallel to the PC board.
- Once the LCD is positioned correctly, solder all pins.

Visual Inspection

- Using the parts placement drawings in Appendix F, re-check the orientation of the LEDs (D1 and D2), LCD (DS1), and all ICs.
- Examine both sides of the PC board closely for solder bridges, cold solder joints, or unsoldered components.

Resistance Checks

- Set both potentiometers to their mid-points.
- The resistance measurements shown below can all be made from the top side of the board. The (-) lead of your DMM should be connected to the ground jumper (\perp) at the left side of the board.

Test Points (+)	Resistance
DS1 (LCD) pins 1-24	> 100 k
J1 pin 6	> 100 k
J1 pin 7	> 100 k
J1 pin 8	> 100 k
J1 pin 10	90-200 k
J1 pin 12	> 100 k
J1 pin 15	< 50 k
J1 pin 16	15-18 k
J1 pin 19	> 100 k

Front Panel Final Assembly

- Cut three 1.25" (32 mm) lengths of hookup wire. Remove 1/4" (6 mm) of insulation from both ends of each wire.
- Locate the 10-turn potentiometer, R1. Look closely at **Figure 5-9**, which shows the positions of the three lugs. The lugs may be labeled 1, 2, and 3, or S, CW, and CCW. 10-turn potentiometer labeling can be confusing, so use the drawing to identify the lugs. **Your potentiometer may be either of the two types shown.**

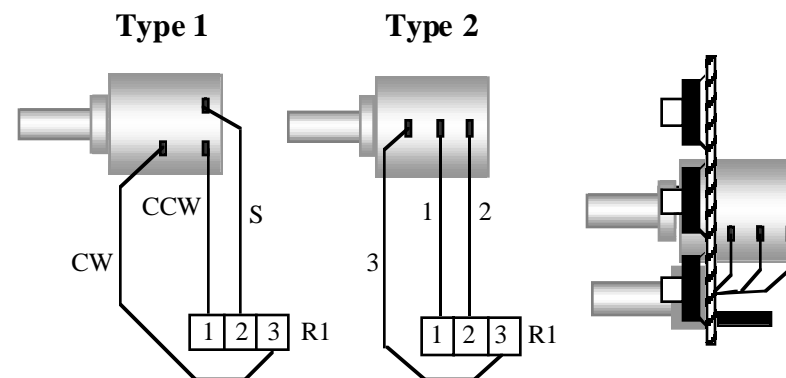

Figure 5-9

- Attach the prepared wires to the three lugs. Each wire should be wrapped around its lug, leaving the other end free. (Do not solder yet.)
 - R1's plastic body can be damaged if you apply too much heat to the lugs. Solder the three lugs, limiting soldering time to about two seconds each.
 - Insert R1 through the large round hole in the Front Panel board, rotating it into approximately the position indicated above. Make sure that none of the lugs are touching the PC board.
 - Near the large hole in the board, you'll find three pads for R1's leads (labeled 1, 2, and 3). Referring to **Figure 5-9**, insert the potentiometer's wires into their corresponding holes. **Do not solder yet.**
- ⚠ Caution: If the leads of R1 are not connected to the correct pads, the potentiometer is very likely to be damaged.**
- Re-check the connections, then solder R1's leads on the top side of the board. Avoid touching nearby parts with the iron.

- Install caps on switches S1 through S6. S3's cap is square, while the others are rectangular, as shown in Figure 5-10. The caps are installed by pressing them onto the switch plungers.

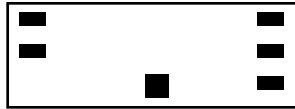



Figure 5-10

 The LCD's glass surface is protected by a very thin, nearly invisible piece of protective film. In the following step, be very careful to remove only the thin film, not the LCD's glass top. Do not use any type of metallic tool.

- Hold the Front Panel PC board assembly under a strong light so that you can see the surface of the LCD glass clearly. Using a fingernail, rub one corner of the LCD's glass top to loosen the protective film, then peel it off.
- Locate the front panel chassis piece. Place it on a soft cloth to protect the finish and labeling.
- Some holes in the front panel are masked on the inside surface during painting. If masking tape (usually green in color) is still present, you'll need to remove it. To remove masking tape:
 - Use a blunt instrument such as a ball-point pen to push on the tape through a hole until the tape begins to lift away.
 - Peel the tape off, using a sharp tool if necessary. Be careful not to scratch the outer surface of the panel.

- After removing any masking tape, turn the front panel face up, with the Elecraft logo at the top.
- Position the clear plastic LCD bezel over the large LCD opening, then secure it with four 2-56 screws (stainless steel) as shown in Figure 5-11. *Tighten the 2-56 screws only the amount needed to hold the bezel to the front panel. Over-tightening may crack the bezel or strip the threaded holes in the panel.*

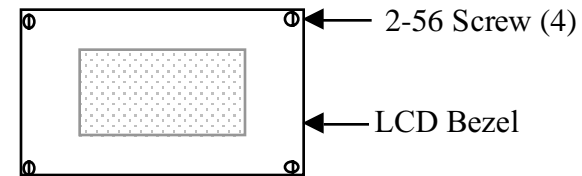

Figure 5-11

- Remove all hardware from the shaft of the 10-turn potentiometer (R1). It will be re-attached in a later step.
- Locate the 0.75" (19 mm) diameter nylon washer. Place this washer over R1's threaded bushing.

- Insert the Front Panel PC board assembly into the front panel (Figure 5-12). The push-button switch caps should protrude slightly.

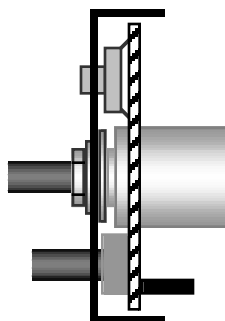

Figure 5-12

- The 1/4" (6.4 mm) standoff on the PC board should now be visible through the countersunk panel hole just below R1. Secure the panel to the standoff with a 3/16" (4.8 mm) flat-head screw.

⚠ Caution: The 10-turn potentiometer may have a plastic bushing. In the following step, do not over-tighten the nut or you may strip the threads.

- Use the nut and lock washer supplied with R1 to secure it to the front panel. It should be just tight enough to keep R1 from rotating.
- Place the large knob on R1's shaft. Push the knob on until it just touches the bushing. If the knob does not spin freely, move it out slightly. If the shaft or knob appears to be tilted, the large nylon washer may not be positioned correctly (behind the panel).

⚠ The Allen wrenches are located in a small bag with the **MISCELLANEOUS** items. These wrenches may have been oiled during manufacturing. Remove the wrenches and wipe off the oil, if any, then discard the bag.

- Use the larger Allen wrench (5/64" [2 mm]) to tighten the two set screws on the large knob.
- Set the AF GAIN and RIT/XIT potentiometers to midway in their rotation, and place a small knob on each. Do not push down hard on the knobs, as this may damage the potentiometers.
- Tighten each knob's two set screws using the smaller Allen wrench (.050" [1.3 mm]). Align the pointers per panel labeling.

⚠ At this point in the assembly, the push-button switches may not all protrude an equal distance. The switch height will become equalized once the front panel assembly is mated to the RF board in a later step.

⚠ When you rotate the VFO knob, you may hear a faint sound produced by the wiper of the 10-turn potentiometer as it moves across its resistance element. This is normal.

Uninstalled Components

- All component locations should now be filled.

6. RF Board, Part I

In Part I, the VFO (variable-frequency oscillator) and receiver sections will be assembled.

□ Open the bag labeled **RF** and sort the components into groups. Observe anti-static precautions when handling transistors and ICs.

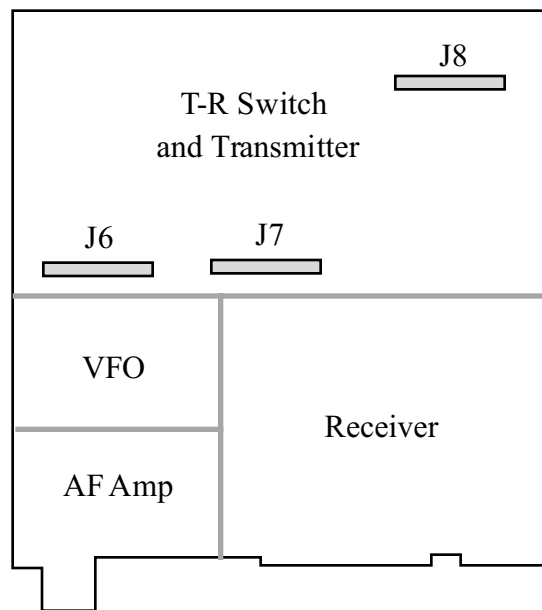

Figure 6-1

□ Locate the RF board and orient it as shown in Figure 6-1. This illustration shows the major areas of the board. Receiver and VFO circuits occupy the front half; transmitter and T-R switch stages use the rear half. The Filter board plugs into J6, J7, and J8.

□ Turn the board over. (Figure 6-2 shows the bottom side.) Four *2-D fasteners* will be attached to the RF board at the indicated locations to secure it to the chassis panels.

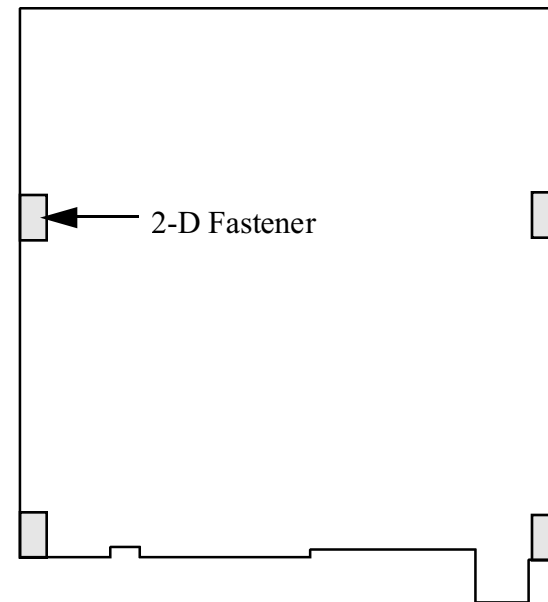

Figure 6-2

- Locate a 2-D fastener and hold it vertically (Figure 6-3a). Looking at a side with two holes, note that the holes are offset from the center. The PC board outlines for the 2-D fasteners have a matching offset, which will aid in installing them in the next step.

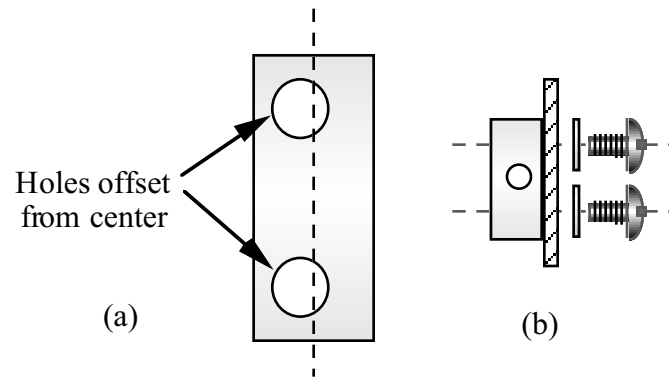

Figure 6-3

- Install 2-D fasteners at the four locations indicated in Figure 6-2, on the *bottom* of the RF board. Secure each fastener from the top side of the board with 3/16" (4.8 mm) pan-head screws and #4 split lock washers (Figure 6-3b).
- Make sure that the 2-D fasteners line up with the edges of the PC board and do not hang over. If they hang over or do not match their component outlines, they are installed backwards.
- Install relay K1, near the center of the board. Make sure the pin 1 end (with the heavy line) is oriented as indicated by K1's component outline. Do not bend or trim the relay leads.

- ⚠ In the steps that follow you'll install the connectors that mate with the Filter and Front Panel boards. These connectors must be installed properly to ensure reliable mechanical connection. They are difficult to remove once installed, so follow all instructions carefully. **Review Figure 3-3 before proceeding.**

- Install an 8-pin female connector at J6, on the top side of the RF board. It must be flush with the board and not tilted (Figure 6-4). Solder just one pin near the center of J6.

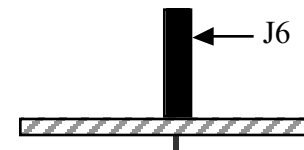

Figure 6-4

- If J6 does not appear to be completely flush with the board, or it is tilted, re-heat the soldered pin and press down. *Do not solder the remaining pins yet.*
- Install J7 and J8 in the same manner as J6, soldering just one pin in each case.
- The Filter board can now be used to check for proper installation of the three 8-pin connectors. Place the Filter board above the connectors (do not plug it in). Verify that all pins of P1, 2, and 3 on the Filter board align with the corresponding holes of J6, 7 and 8 on the RF board.
- Remove the Filter board. Solder all remaining pins of J6, 7, and 8 on the bottom of the RF board.

- Position 20-pin male right-angle connector P1 on the **bottom** of the RF board (Figure 6-5), but do not solder yet. **Review Figure 3-3 for correct placement.** The short ends of the bent pins are inserted into the holes, and the long ends are parallel to the board.

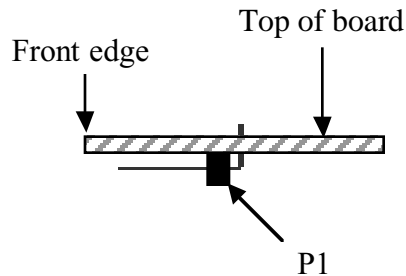

Figure 6-5

- Solder just the two end pins of P1.
- Make sure that the front-panel assembly can be plugged into P1 as shown in Figure 3-3. Then unplug the front panel assembly.
- Look closely at P1 to make sure that its plastic support is pressed down as far as it will go, and that the pins are parallel to the board. If not, re-heat the soldered ends while pressing it into place. Once it is seated properly, solder the remaining pins.



In the steps that follow, you'll be installing larger groups of components. When working from a long list, install all of the items on one line before moving on to the next. Arrows (\Rightarrow) appear in the list to remind you of this order. In general, assembly proceeds from left to right across the board.

Note: All components mounted in the T-R switch and transmitter areas must be kept as low-profile as possible since the Filter board will be plugged in directly above.

- Install the resistors listed below. R23 is at the left-front edge.
- | | |
|---------------------------------------------------|-----------------------------|
| __ R23, 1.5 Ω (BRN-GRN-GOLD) \Rightarrow | __ R7, 680 (BLUE_GRAY-BRN) |
| __ R21, 2.7 k (RED-VIO-RED) | __ R13, 2.2 M (RED-RED-GRN) |
| __ R2, 100 k (BRN-BLK-YEL) | __ R16, 75 (VIO-GRN-BLK) |
| __ R17, 120 (BRN-RED-BRN) | __ R18, 75 (VIO-GRN-BLK) |
| __ R14, 2.7 k (RED-VIO-RED) | __ R1, 1.8 k (BRN-GRAY-RED) |

These resistors start on the left edge of the board near J6:

- | | |
|------------------------------------------|------------------------------|
| __ R19, 39 k (ORG-WHT-ORG) \Rightarrow | __ R20, 20 k (RED-BLK-ORG) |
| __ R9, 2.7 k (RED-VIO-RED) | __ R26, 1.8 k (BRN-GRAY-RED) |

- __ R34, 100 k (BRN-BLK_YEL) (at the back-right edge near J8)

- The following capacitors are all of the disc or monolithic type. Start with C26, which is on the left edge close to J6.

Note: C65 (22 pF) may be labeled "220J" (see top of page 9).

- | | | |
|-------------------------------|--------------------------------------|-----------------------|
| __ C26, 39 (39) \Rightarrow | __ C27, 39 (39) \Rightarrow | __ C42, 220 (221) |
| __ C41, .047 (473) | __ C30, .047 (473) | __ C40, .01 (103) |
| __ C25, .01 (103) | __ C7, 39 (39) | __ C4, .01 (103) |
| __ C6, .01 (103) | __ C69, 220 (221) | __ C72, .01 (103) |
| __ C18, .01 (103) | __ C74, .01 (103) | __ C73, 0.1 (104) |
| __ C64, .01 (103) | __ C68, 0.1 (104) | __ C17, .01 (103) |
| __ C32, .047 (473) | | |
| __ C70, 0.1 (104) | __ C71, 0.1 (104) | __ C23, .01 (103) |
| __ C75, .01 (103) | __ C63, 330 (331) | __ C65, 22 (22, 220J) |
| __ C61, .047 (473) | __ C24, .047 (473) | __ C19, .001 (102) |
| __ C66, .01 (103) | __ C21, .01 (103) | __ C22, .001 (102) |
| __ C39, 220 (221) | __ C37, .01 (103) | __ C38, 220 (221) |
| __ C36, .01 (103) | __ C34, 0.1 (104) | |
| __ C28 and __ C29, .001 (102) | (back-left corner of the board) | |
| __ C49 and __ C48, .01 (103) | (back-right corner) | |
| __ C45, .01 (103) | (near J4, which is on the back edge) | |

- 1200-pF polystyrene capacitor C11 (labeled "1200J") has axial leads, like a resistor. **Note: the kit also includes a 120 pF polystyrene ("120J").** Install C11 in the VFO area of the board, near J6. Limit soldering time to 2-3 seconds.

Install the resistor networks listed below, checking the part numbers carefully before installation. Orient the black dot or bar on each network towards pin 1 of its component outline.

__ RP3, 47 k, 10 pins (10A3473G, 103C104, or 770103473)
 __ RP1, 100 k, 8 pins (8A3104G, 83C104, or 77083104)
 __ RP2, 100 k, 8 pins (8A3104G, 83C104, or 77083104)
 __ RP6, 27 k, 6 pins (6A3273G, 63C273, 4306R-102 LF273 or 77063273)
 __ RP4, 3.9 k, 6 pins (6A3392G, 63C392, 94163392P or 77063392)
 __ RP5, 3.9 k, 6 pins (6A3392G, 63C392, 4163392 or 77063392)

Install a 33- μ H RF choke (ORG-ORG-BLK) at RFC1, near the front edge of the board. (Orange bands may appear to be brown.)

Install a 100- μ H RF choke (BRN-BLK-BRN) at RFC4, in the transmit area of the board.

The ceramic trimmer capacitors (C13 and C20) have one side that is flattened. This side must be oriented towards the flattened side of the component outline. Install C20 near the front edge of the board, and C13 in the back-left corner.

Sort the diodes into groups for identification purposes. You should have two types of small glass-bodied diodes: 1N5711, and 1N4148. The 1N4753 zener diode may also be glass, and is larger. If necessary, use a magnifying glass to read the labels.



Diodes with long axial leads (such as the types mentioned above) must be installed with the banded end (cathode) oriented towards the banded end of their component outlines. If a diode has more than one band, the *widest* band indicates the cathode end.

Install 1N4148 diodes at D17 and D1, observing the proper orientation as explained above. Do not solder yet. D17 and D1 are both near RP2, in the VFO area.

Install 1N5711 diodes at D2 and D15, but do not solder yet. D2 is in the VFO area. D15 is in the back-right corner near J8.

Re-check the orientation of the diodes, then solder.

Identify the two types of black, axial-lead diodes: 1N4007 and SB530. The 1N4007 is the smaller of the two.

Install the SB530 diode at D16, near the back edge of the board.

Install 1N4007 diodes at D11 and D10, to the left of D16.

Install a 1N4007 diode at D5, near J7.

The varactor diodes have a small plastic package, like a TO-92 transistor, but with only two leads. Sort the varactor diodes into two types: MV209 (quantity 1) and 1SV149 or V149SL (quantity 4).

Install the varactor diodes listed below. The flat side of each diode must match the flat side of its PC board outline. Bend the leads slightly on the bottom to hold the diodes in place.

__ D4, MV209 (in the VFO area)

Note: The 1SV149 diodes may have a third lead in the center, cut off near the body. Mount them slightly above the board to avoid letting this lead short the two pads together.

__ D3, 1SV149 (in the VFO area)
 __ D6, __ D7, __ D8, 1SV149 (right-front corner)



TO-92 package may have either of the package types shown in Figure 5-4 (page 19). Orient the large flat side of the package with the flat side of the component outline. Verify the part numbers using a magnifying glass if necessary.

Install the TO-92 package transistors listed below, starting with Q9 in the VFO area. *Observe anti-static precautions.*

__ Q9, 2N3906 \Rightarrow __ Q8, J309 \Rightarrow __ Q11, J309
 __ Q10, 2N7000 __ Q2, MPSA14 __ Q1, 2N7000
 __ Q3, 2N4124



Transistor Q4 (ZVN4424) is labeled on the back (the side with smaller area), which is different from most TO-92 devices.

The labeled side of Q4 must face the power switch, S1.

Install Q4 (ZVN4424A) in the back-right corner near S1.

Install U6 (78L06) near the left edge of the VFO area.

Install the 8-pin ICs listed below. Orient the notched or dimpled end of each IC with the notched end of its component outline (see Figure 4-7). Make sure the part numbers on the ICs match the numbers on the component outlines.

__ U4, LM380N-8 (do not confuse with U3--check part numbers carefully)

__ U3, LM386N-1

__ U2, __ U7, and __ U1, SA602AN (alternates: NE602, SA612, NE612)

Install the following components on the bottom of the board, soldering them on the top side. **Note:** R3 is easier to solder on the bottom. In this case, pre-trim the leads to the correct length.

__ R3, 8.25 k, 1% (GRAY-RED-GRN-BRN) (see note above)

__ R15, 10 ohms, 5% (BRN-BLK-BLK)

__ R5 and __ R6, 2.7 k (RED-VIO-RED)

__ R27, 1.8 k (BRN-GRY-RED)

__ D12, 1N4007 (black body)

__ RFC6 and __ RFC7, 100 μ H (BRN-BLK-BRN)

__ C5, 3300 pF polystyrene (3300J)

__ C12, 1200 pF polystyrene (1200J)

Install C8 (82 pF) on the bottom of the board, near P1. Before soldering, fold it down against the board, towards the back.

On the top and bottom sides of the board near J7 you'll find short jumpers ($\frac{1}{2}$). Install U-shaped wires at both locations.

Locate the DC power switch, S1. Install S1 near the back of the board, with the plunger facing the back edge. *Make sure S1 is pressed firmly onto the board, and that it is not tilted.*

Push the black keycap onto S1's plunger until it snaps.

Install the DC input jack, J4, at the back edge. The 3 leads on the jack must be lined up with the slot-shaped holes in the component outline. If the holes are a tight fit, press firmly until the connector snaps into position, flat against the board.

Visual Inspection

Verify correct orientation (banded end) of each diode installed so far, using the parts placement drawing (Appendix F).

Examine both sides of the PC board closely for solder bridges, cold solder joints, or unsoldered components.

Resistance Checks

Make the resistance checks listed below, with your DMM's (-) lead connected to the ground jumper ($\frac{1}{2}$) near J7. The measurements on P1 (the 20-pin right-angle connector) should be taken from the bottom side of the board.

Test Points (+)	Resistance
P1 pin 6	> 100 k
P1 pin 7	> 100 k
P1 pin 8	> 100 k
P1 pin 12	> 10 k
P1 pin 14	> 100 k
P1 pin 15	> 100 ohms
P1 pin 16	> 1 k
P1 pin 17	> 1 k
U3 pin 3	< 200 k
U3 pin 5	> 10 k
U4 pin 3	> 50 k
U4 pin 6	> 10 k
U4 pin 7	> 1 k

 Electrolytic capacitors are mounted vertically, so their PC board outlines are circular. The (+) lead must be installed in the hole marked with a "+" symbol. The (+) lead is usually longer than the (-) lead, and the (-) lead is identified by a black stripe (Figure 6-6).



Figure 6-6

Install the electrolytic capacitors listed below. They must be seated as close to the PC board as possible to avoid interfering with option modules that you may install later. **Note:** The 10- μ F capacitors are of the low-profile type, so they may be smaller than the 2.2- μ F capacitors.

__ C33, __ C59, and __ C35, 10 μ F (see note above)
 __ C54, __ C31, and __ C67, 2.2 μ F
 __ C9, __ C10, and __ C53, 220 μ F

8-volt regulator U5 (LM2930T-8) is a TO-220 package device with 3 leads (see photo in parts list). Mount U5 vertically at the back edge of the PC board (Figure 6-7). Only the wide part of the leads should be above the board. The hole in the tab of U5 will not be used for mounting, so positioning is not critical.



Figure 6-7

Locate the component outline for RFC8, on the bottom of the RF board in the transmitter area. Install a short wire jumper at RFC8, formed from a component lead or solid hookup wire.

Note: an RF choke may be supplied with the 80-meter band kit (2-band Filter board only) for use at RFC8. This RF choke can be installed at any time, and will have no effect on K1 alignment or testing on any band. Its function is to improve stability on 80 meters when the K1 is used with poorly-matched loads or an ATU.

DC Voltage Checks

Set power switch S1 to its OFF position, with the plunger *out* (extended toward the back).

Connect a 12 to 14-V DC power supply or battery to J4. If your power source does not already have a plug that mates with J4, use the supplied mating plug and prepare a suitable power cable. The center lead of the plug is positive (+).

Turn on S1. **If you see or smell smoke, or a component feels hot to the touch, disconnect the power source immediately.** Locate the source of trouble before proceeding.

Using your DMM's DC voltage setting, make the DC voltage checks listed below. The (-) lead of your DMM should be connected to one of the ground jumpers.

 Be careful not to short adjacent pins of ICs with the DMM probe (use only a fine-point probe).

Test Point (+)	DC Voltage
P1 pin 15	5.8-6.2
P1 pin 16	(supply - 0.3 V)
U3 pin 5	3.8-4.2
U3 pin 6	7.6-8.7

- Turn the K1 off and disconnect the power supply.
 - Install the headphone jack, J2, on the small board extension near the front-left corner. The pins on J2 are not very long, so they will be nearly flush with the bottom of the board. Solder the pin closest to the front edge first (ground), then verify that the jack is seated flat on its plastic nubs before soldering the other pins.
- Mono Headphones:** If you plan to use *only* a mono plug at J2, cut the trace marked "cut = mono" on the bottom of the board, under J2. (You'll lose the sound on one side of stereo headphones.)
- Install the key jack, J3, at the back-left corner. Before soldering, make sure that the jack is aligned with its PC board outline.
 - Install the antenna jack, J5 (BNC), in the back-right corner. Solder one of the large ground mounting pins first. If J5 then appears to be tilted or twisted, reheat this ground pin while pushing J5 down onto the board. Once it is seated properly, solder the remaining pins.
 - The internal speaker connector, P2, is a 2-pin connector with a locking tab. Orient P2 as shown by its PC board outline, near the front-right corner of the board, with the locking tab facing the front. P2 must be seated flat against the board before soldering.
 - Install crystal X5, near the front edge of the board. Make sure it is flat against the board and not tilted before soldering. (The leads can be bent to hold it in place.)
 - Install X6 near the back-left corner.
 - Install X1-X4 at the front-right corner.
 - Ground the cases of all six crystals, using the near-by ground pads. Use discarded component leads as before. Limit soldering time to 4-5 seconds to avoid overheating the crystals.

- Install R39 (1.8 k, BRN-GRAY-RED) on the bottom of the board near crystal X6.
- In the back right corner of the board near the antenna jack (J5), install P3, a 3-pin male connector. The long end of P3's pins face up.
- Install the two-pin shorting jumper across pins 1 and 2 of P3 (the two terminals closest to J5).
- On the bottom of the board, install R4 (5.6 k, GRN-BLUE-RED).
- Locate the miniature slide switch, S2. Install S2 on the bottom of the board, with the switch pressed down onto the board as far as it will go. (If it isn't pressed all the way down, the actuator might hit the bottom panel.) Limit soldering time on each of S2's pins to 2 seconds to avoid melting the plastic body.
- Set S2's actuator to the "OPER" (operate) position.
- Locate the component outline for RF choke RFC9, on the bottom of the board between the pins of relay K1. Flush-trim the four pins of K1 closest to RFC9.
- Form the leads of RFC9 (15 μ H, BRN-GRN-BLK) to fit between the indicated pads. Install RFC9 and position its leads so that they don't contact any adjacent pads of K1. Solder and trim RFC9's leads from the top side of the board.

Locate the dark gray (ferrite) toroid cores. You should have four smaller cores (type FT37-43) and one larger core (FT50-43). The three inductors to be wound in the following steps, L2, T1, and T2, all use the smaller ferrite cores.

 Review the toroid winding and lead preparation instructions if necessary (page 14).

Wind L2 using 16 turns of red enamel wire (11 inches, 28 cm). L2 should appear similar to Figure 4-3, on page 14 (the figure shows 14 turns rather than 16). Recall that each pass of the wire *through* the core counts as one turn.

Prepare L2's leads as before (page 14). Remove the insulation to within about 1/8" (3 mm) of the core, then tin the leads.

Install L2 vertically, at the back edge of the RF board between the on-off switch (S1) and the antenna jack (J5).

 T1 is a toroidal *transformer*, with two numbered windings. These numbers are printed next to each pad on the PC board. T1's windings are 1-2 and 3-4.

T1 is wound on an FT37-43 ferrite core (dark gray) and has windings similar to those shown in Figure 6-8a. Wind the 3-4 winding first, using 20 turns of red enamel wire (13", 33 cm). This winding should occupy 80 to 90% of the core. *Note: the drawing shows only 14 turns.*

Wind the 1-2 winding on top of the 3-4 winding, using 4 turns of green enamel wire (6", 16 cm). These turns should be wound tightly, and will overlap the turns of the first winding. (The drawing shows the turns interleaved, for clarity, but this is not required.)

Strip and tin all four of T1's leads carefully.

Install T1 flat against the board, between U1 and U2. Insert the leads into its numbered holes as shown by the component outline. Pull the leads taut on the bottom, then solder and trim.

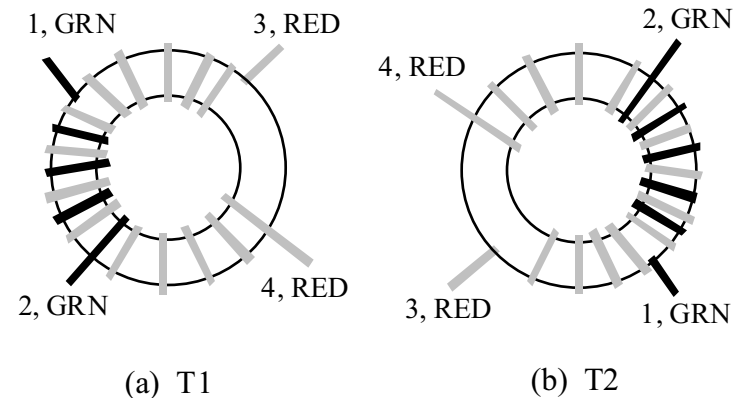

Figure 6-8

T2 is wound on the same core type as T1. Start with the 3-4 winding, which uses 20 turns of red enamel wire (13", 33 cm). The 1-2 winding uses 5 turns of green enamel wire (6", 16 cm).

Strip and tin T2's leads.

Install T2 flat against the board, to the right of U2. Pull the leads taut, then solder.

Using your DMM, check for continuity between the pads of L2. If the DMM doesn't indicate a short (< 5 ohms), you may not have fully removed the insulation from one or both leads. Since the insulation can be heat-stripped, you can usually improve the electrical connection by re-heating each lead for 4 to 5 seconds.

Similarly, check T1's two windings (1-2 and 3-4) for continuity. Then check T2's windings.

 Toroidal inductor L1 (VFO) will not be installed until the VFO is aligned in Alignment and Test Part I (page 36).

- On the top side of the RF board, locate the hole identified as (A) in Figure 6-9. (The label "S1" appears near the hole.)

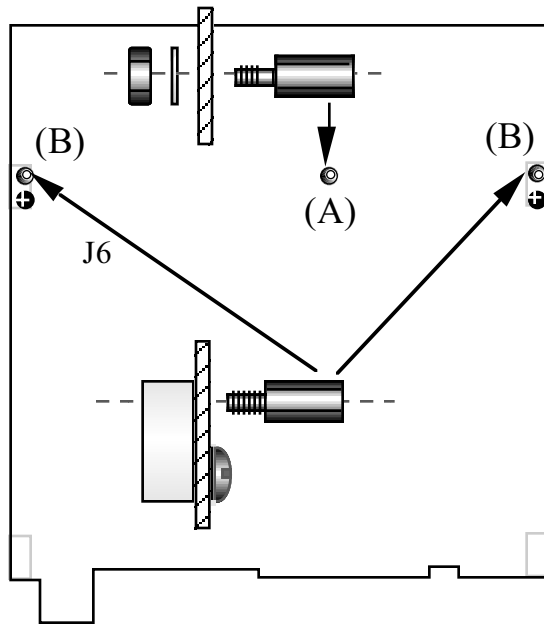



Figure 6-9

- Install a 7/16" (11 mm) hex male-female standoff on the top of the board at location (A) as shown. Use an internal-tooth lock washer and 4-40 nut on the bottom. Do not over-tighten the hardware; the standoff threads can be easily stripped.
- Install 7/16" (11 mm) hex male-female standoffs at the two locations identified as (B) in Figure 6-9, replacing the existing 3/16" pan-head screws. *Do not use any lock washers.*
- Temporarily place the Filter board assembly on top of the three standoffs just installed. If the standoffs are in the correct positions, they will be visible through their holes in the Filter board.

-  When working with the side panels in the following steps, place a soft cloth on your work surface to protect the paint. (A clean anti-static mat will also suffice.)

- Locate the two side panels and arrange them as shown in Figure 6-10, with the inside surfaces facing up. The right side can be identified by the presence of an extra hole as shown. The illustration also shows where 2-D fasteners will be installed, as well as the areas which were masked during painting.

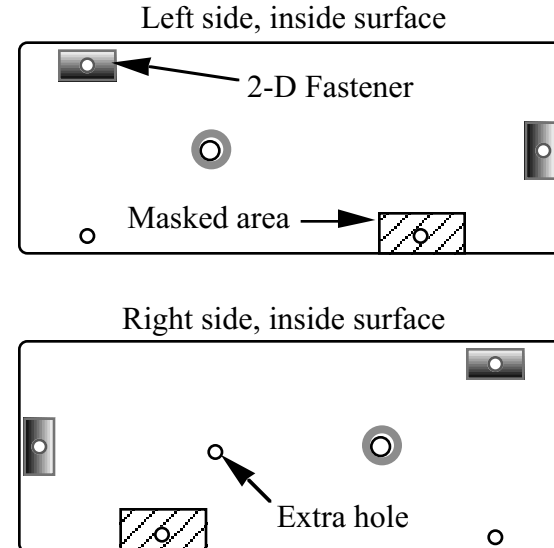

Figure 6-10

- Remove any masking tape from the panels using the same technique described on page 23, taking care not to scratch the outer surfaces.



Flat-head screws are more easily damaged than pan-heads. Do not use excessive force when tightening them.

□ Attach two 2-D fasteners to each side panel at the locations indicated in Figure 6-10. (Make sure that the holes are countersunk; if not, you may be working with the wrong side of the panel.) Use one 3/16" (4.8 mm) flat-head screw to hold each 2-D fastener to the side panel (Figure 6-11). The two unused holes on each fastener must be offset *away* from the side panel as shown.

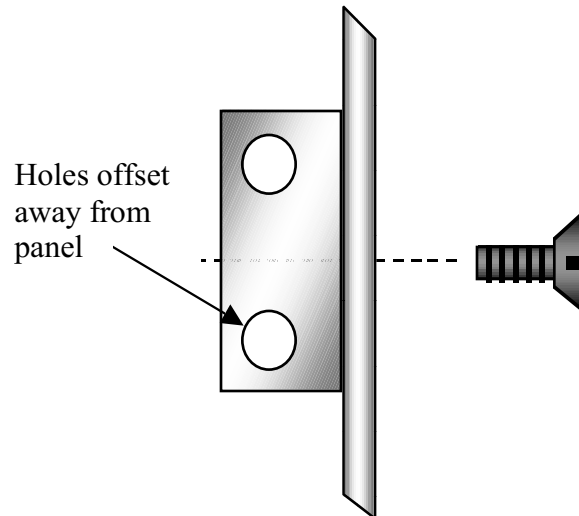

Figure 6-11

□ Attach the side panels to the RF board using two 3/16" (4.8 mm) flat-head screws per side panel. The side panels are attached using the 2-D fasteners that are already in place on the RF board. Figure 6-12 shows the approximate location of the two screws used to secure the right side panel.

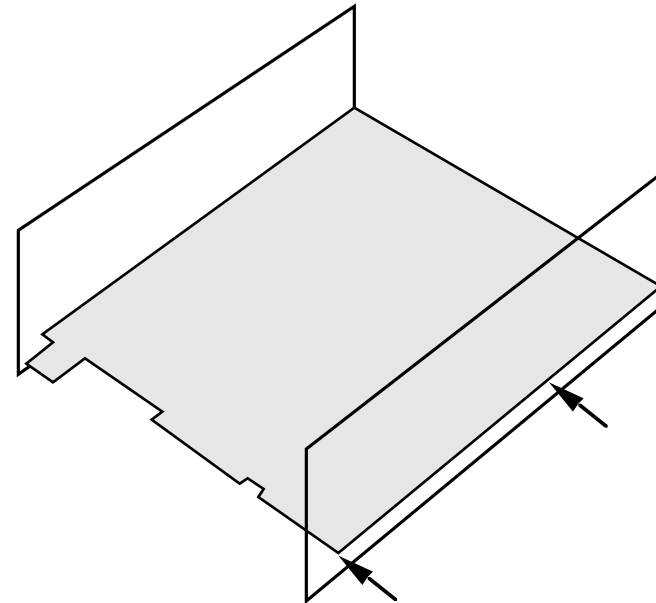

Figure 6-12

- With the assembly upside-down or resting on one side, plug the front panel assembly into the RF board (Figure 6-13). Connector J1 on the bottom of the front panel PC board mates with P1 on the bottom of the RF board (indicated by an arrow below).

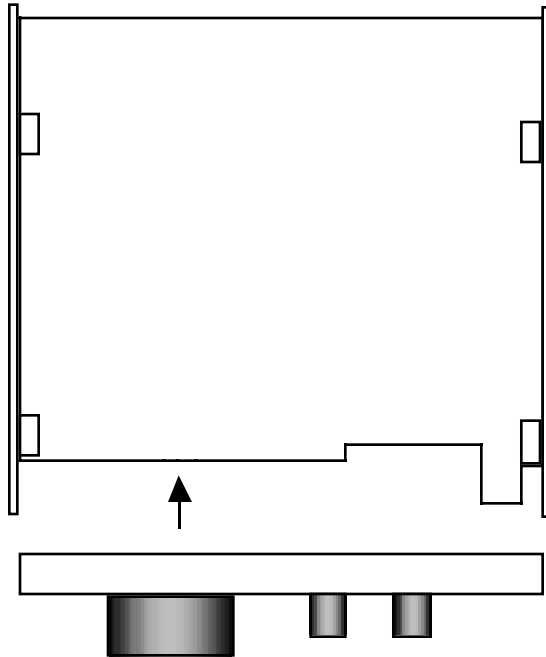

Figure 6-13

- Secure the front panel to the side panels and RF board using *two flat-head* and *two pan-head* 3/16" (4.8 mm) screws. Flat-head screws are used on the top, and pan-head on the bottom. You may need to adjust the 2-D fasteners slightly, then re-tighten all hardware.



The switches should now be accessible, and the headphone jack should be even with the front panel. Also, the LEDs above the VFO knob should be visible. If any of these controls are not properly situated, you may not have the Front Panel fully plugged into the RF board.

Note: The coaxial jumper to be installed in the following steps is referred to as W1 in the RF board parts list.

- Cut a 2.6" (67 mm) length of RG-174 coax cable. Using a sharp tool, remove about 3/8" (9 mm) of the coax jacket from each end. Be careful not to nick the braid.



Figure 6-14

- Separate the braid (shield) from the center conductor at both ends (Figure 6-14). Clip off about half the strands of the braid close to the jacket, then twist the remaining braid into a fine bundle.
- Remove a small amount of insulation from the center conductor. Use long-nose pliers to hold the center conductor while stripping it, or you may pull it out of the coax jacket.
- On the bottom of the RF board you'll find the component outlines for two 2-pin connectors, J9 and J10. Install the coax cable on the bottom of the board between these two points. The center conductor should be inserted into pin 1 of each connector (square pad), and the braid into pin 2 (round pad). *Do not solder yet.*
- Make sure that the coax braid is not touching any adjacent pads at either end, and that the coax is not covering the nearby screw mounting hole. Solder the coax (on the bottom side of the board). Trim the leads on the top side if there is excess lead length.

7. Alignment and Test, Part I

In this section you'll become familiar with K1 operation, while testing control circuits and aligning the VFO and receiver.

The Tap/Hold Rule

Each of the push-button switches on the front panel has two functions, one activated by a TAP (short press) and the other activated by a HOLD (long press, about 1/2 second). The upper label on each switch shows the TAP function (white lettering), and the lower label shows the HOLD function (yellow lettering). To highlight this in the text, we use two different typographical styles to identify switches: **TAP** and **HOLD**.

Initial Tests



If any test or alignment step fails, refer to the Troubleshooting section (Appendix E).

- To improve the visibility of the LCD during testing, you should prop up the front edge with a non-conductive object (small box, book, etc.). **Note:** Do not attach the KTS1 tilt stand at this time. With the bottom cover removed, it could cause a short.
- Set AF GAIN fully counter-clockwise (minimum volume).
- Make sure the K1 is turned OFF (power switch S1 out).
- Plug your power supply or battery into J4 on the rear panel.

LED Test



When you turn the K1 on the next step, watch for the *LED test*. You should see the ATTN (yellow) LED turn on briefly, followed by the RIT/XIT dual-color LED (green, then orange).

- Turn on power to the K1. **If you see or smell smoke, or a component feels hot to the touch, disconnect the power source immediately.** Locate the source of trouble before proceeding.
- If you did not see the LED test, refer to Troubleshooting.

LCD and Error Codes

You should now see **E27** on the LCD. This is an *error code* which occurs when the K1 self-test finds that the Filter board is not plugged in. (Error codes are listed and described in the Troubleshooting tables.)



If the LCD is blank, it may indicate that one or more switches are closed. Check for shorts on all switch lines.

Tap any switch to clear the error code. You should then see **E42**, which indicates that the self-test found the VFO signal missing. This is correct, since the VFO inductor, RF-L1, has not yet been installed. (When the VFO is functioning normally, you'll see the operating frequency displayed.)

Sidetone Generator and Audio Amplifier

Plug in a pair of stereo headphones, and rotate the AF GAIN control clockwise to about 9 or 10 o'clock.

Tap **MENU**. The first menu entry will be displayed: **OUT** (transmit power output). Tap **WPM+** to select the next menu entry, **STL** (sidetone volume). (Lower-case "t" is used.)

The Sidetone can be activated by *editing* the **STL** menu parameter. Hold **EDIT** to show the parameter and turn on the sidetone. You can then use **WPM+** and **WPM-** to vary the sidetone level, from **0-31**. Select a comfortable level, then tap **MENU** to turn off the sidetone and return to the **STL** display.

Note: **STL** is used to set the sidetone volume level in relation to normal received audio. However, the AF GAIN control sets the overall headphone or speaker volume.

Select the sidetone pitch menu entry (**STP**) using by tapping **WPM+**. Hold **EDIT** to turn on the sidetone and edit the pitch parameter. The pitch can be varied from **400** to **800** Hz using **WPM+** and **WPM-**. Select the desired pitch, then tap **MENU** to end parameter edit and return to **STP**.

Tap **MENU** again to return to the normal display (in this case **E42** because of the missing VFO signal).

Voltmeter

On power-up, the LCD shows the operating frequency, with 100-Hz resolution. Holding **DISPLAY** once selects S-meter mode. Holding **DISPLAY** again selects voltmeter mode. You should see **BAT** flash briefly on the LCD, then your approximate power supply or battery voltage, which will continue to flash slowly.

Return to the operating frequency display by holding **DISPLAY** again. You should see **E42**, as explained previously.

Keyer

Note: If you don't have a keyer paddle, you can still test the DOT and DASH lines by using test clips to touch them to ground.

Plug a keyer paddle into the key jack (J3). *The plug must be stereo (2 circuit).* A stereo plug is supplied with the kit.

Tap **MENU** and locate the **INP** menu entry (CW input device selection). Hold **EDIT** to see the parameter, which defaults to **Hnd** (hand key or external keyer). Use **WPM+** and **WPM-** to select either **PDn** or **PDr** (paddle normal, or paddle reverse). Then tap **MENU** twice to return to the VFO display.

Select the keyer speed using **WPM+** and **WPM-**. If you tap these switches quickly, the speed will jump 2 WPM at a time.

While listening with headphones, test the keyer paddle to verify that both dot and dash are working.

If you use a dual-lever keyer paddle, you may wish to use the menu's **IAB** entry to select *iambic* mode A or B (page 55).

Relays (Filter Board and Attenuator)

Turn off the K1.

Plug in the Filter board assembly. The connectors on the Filter board must be fully inserted into J6, 7 and 8 on the RF board.

Turn the K1 on. The LCD should show **E42**. You may also hear one or more relays switching.

Tap **BAND** *twice* (quickly) to change to the next band. Tap **BAND** two or more times quickly to return to **7.0** MHz.

Test the attenuator relay and the yellow LED by holding **ATTN**. Hold **ATTN** again to turn the attenuator off.

VFO Alignment

- Turn the K1 off and disconnect the power supply.

Two different capacitors are supplied for setting the approximate VFO range: C2 (68 pF disc) and C2A (120 pF polystyrene). 68 pF provides a range of about 80 kHz; 120-pF provides a range of about 150 kHz. Other values can also be used (builder-supplied).

- Based on your VFO range selection (page 12), install the appropriate capacitor at C2. Save the other for possible future use. If you use the 68-pF disc cap, pre-form the leads to match the pad spacing for C2.

- Wind L1 on a T50-6 toroid core (yellow, 1/2" [12 mm] diameter). Use 24 inches (61 cm) of red enamel wire. Wind 33 turns on L1, leaving the two leads about 1/2" (12 mm) long.

- Adjust the turns of L1 so that they are fairly evenly spaced and occupy about 90% of the core.

- Strip and tin the leads of L1 to within 1/8" (3 mm) of the core. (Review toroid lead preparation instructions, page 14.)

- Secure L1 loosely to the PC board as indicated by its component outline, near J6. As shown in Figure 7-1, use *two* nylon washers, a 1/2" (12 mm) nylon screw, and nylon 4-40 nut.

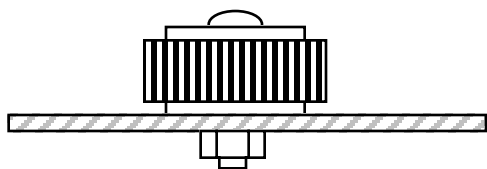

Figure 7-1

- Insert L1's leads into their pads and solder.
- Connect the power supply and turn the K1 on.

VFO Range Test

- Tap **MENU** and locate **CAL**. To enable the operating frequency calibration display (**OPF**), hold **EDIT**. The 100-Hz digit should be flashing. (If you see **E42**, the VFO is not functioning.)

- To see the VFO frequency, you'll use CAL's other display mode, **OSC**. To select this, hold **DISPLAY**. You'll see **OSC**, followed by the VFO frequency in MHz (1 digit), then kHz (3 digits). For example, 3.012 MHz would be shown as **3**, then **012**.

- Make sure that the VFO frequency goes *up* as the VFO knob is rotated *counter-clockwise*. If not, see Troubleshooting.

- Rotate the VFO knob fully *clockwise* until it stops, then note the frequency: _____ kHz. Rotate it *counter-clockwise* until it stops and note the frequency: _____ kHz. Subtract the low reading from the high reading to obtain the VFO range: _____ (about 80 or 150 kHz, depending on the value of C2).

VFO Range Adjustment

- Make sure the VFO knob is rotated fully counter-clockwise.

- If the frequency shown is now higher than 3.100 MHz**, *squeeze* the turns of L1 (bunch them more closely together) to lower the frequency. You can squeeze the turns by hand, or use the tuning tool. Watch the frequency display as you adjust the turns.

- If the frequency shown is lower than 3.090 MHz**, *spread* the turns of L1 out. This raises the VFO frequency. If the frequency cannot be raised to at least 3.090 by spreading the turns out, you may need to remove one turn from L1 (the non-grounded end).

Note: The final VFO frequency should be between 3.090 MHz and 3.100 MHz to make sure that the low end of each band is covered.

- Once the turns on L1 have been correctly adjusted, tighten the nylon screw so that the L1's turns are held firmly in place. (This may shift the indicated frequency slightly.)

Band Assignments

To see the correct display when you tap **BAND**, you'll need to specify which bands are covered by your Filter board.

- If you're still in the **CAL** menu entry, tap **MENU** to exit.
- Locate the **B1** menu entry (note that the "b" actually appears in lower-case). If **B2**, **B3**, or **B4** is shown, tap **BAND** to change it to **B1**.
- To check the present assignment for band 1, the lowest-frequency band, hold **EDIT**. The default is **7.0** MHz. Use **WPM+** or **WPM-** to specify band 1.

 On 30 meters, you have a choice of two band edges (**10.0** or **10.1**), depending on your VFO range selection (from page 12). The appropriate band edge is set by holding **DISPLAY**.

- Tap **MENU** to return to the **B1** display, then tap **BAND** to switch to **B2**. Hold **EDIT** again to show the band 2 assignment.
- Use **WPM+** and **WPM-** to specify band 2. If band 2 is 30 meters, select the band edge using **DISPLAY**.
- In the same manner, specify band 3 and band 4, if applicable (four-band module only; see KFL1-4 manual, page 16).
- Tap **MENU** twice to exit the menu.
- To re-check the band assignments, tap **BAND**. The current band will be displayed (in MHz), followed by a 3-digit display (1 kHz resolution), followed by the normal frequency display (to 100 Hz). For example, if the band is 40 meters and the VFO is set to 7025.3 kHz, tapping **BAND** will show **7**, then **025**, and finally **25.3**. Tapping **BAND** twice (quickly) switches to the other band.

Receiver Alignment

This section applies only to the two-band Filter board. If you have a four-band Filter board installed, refer to the KFL1-4 manual, page 17.

- Set the BFO trimmer, C20, so that its adjustment slot is parallel to the nearby crystal. (C20 is located near the front edge of the RF board.) The final setting of C20 will be determined later.
- If the present band is not band 1 (the lower frequency band), tap **BAND** twice quickly to select it.
- Make sure that the attenuator (yellow LED) is off.
- Plug in a pair of headphones or an external speaker, and adjust the AF GAIN control until you hear some background noise. If you do not hear any background noise, refer to Troubleshooting.
- Set the VFO to about the mid-point of the present band (7.050 MHz on 40 meters, 10.125 MHz on 30 meters, etc.). Tap **BAND** if necessary to verify that you're in the right 100-kHz band segment.
- Connect an appropriate antenna for band 1. At minimum, connect approximately 20-30 feet (6 to 9 meters) of any type of wire to the center conductor of J5. In general, the longer and higher the antenna, the more signal strength that will be available during receiver alignment.

 Receiver alignment will be easiest if you use a ham-band transmitter or signal generator to create a very strong signal that can be located with the K1. If you use a transmitter, be sure to connect it to a dummy load and operate it at low power.

Band-Pass Filter Alignment

On the Filter board, there are premix filters and RF filters for each band, as shown in Figure 7-2. Each filter has two slug-tuned inductors. These filters will be peaked in the following steps.

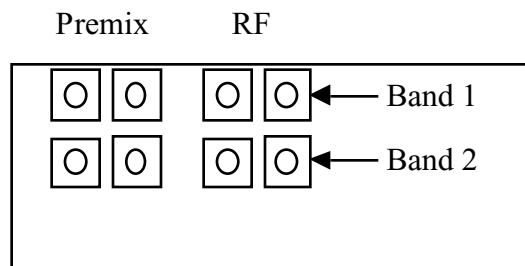

Figure 7-2

- Locate the plastic tuning tool. The smaller end of the tool will be used to adjust the slug-tuned inductors.
- While listening to atmospheric noise or a CW signal, peak the two band-1 Premix inductors, L1 and L2. *Do not continue to turn the slug if it has bottomed-out. Stop when you feel resistance.* If you cannot find a peak for L1 and L2, set them to about the mid-point of their range for now and go on to the next step.
- Peak the two band-1 RF inductors, L5 and L6. If no signals are heard while peaking either L1/L2 or L5/L6, use a transmitter to generate a stronger signal, or scramble the settings and try again.
- Re-peak L1 and L2, then L5 and L6, until no further improvement is noted. Once all four inductors have been peaked, received signals and noise should be quite strong.
- Tap **BAND** twice (quickly) to select band 2.
- Switch to an appropriate antenna for this band, if available, and set the VFO for the mid-point of the band.

- While listening to noise or a weak signal, peak the band-2 Premix inductors, L3 and L4.
- Peak the two band-2 RF inductors, L7 and L8.
- Re-peak L3 and L4, then L7 and L8, until no further improvement is noted.

Coarse BFO Alignment

- The K1 three crystal filter bandwidths are selected by holding the **XFIL** switch. Hold **XFIL** until you see **FL3** on the LCD.
- Note:** FL1, 2, and 3 are pre-set to bandwidths of about 800, 400, and 250 Hz. They can be set up differently using **FLx** (page 53).

- Tune in a moderately-strong signal. Adjust the VFO slowly to find the pitch where the signal is strongest. At this point, the signal will be centered in the crystal filter.
- Locate the BFO trimmer, C20, near the front edge of the RF board. Adjust C20 for approximately the desired signal pitch.

Fine BFO Alignment Using the Sidetone Pitch

- Select your desired sidetone pitch using the **STP** menu entry. (Many CW operators use 500-600 Hz or lower.) Exit the menu.
- Tune in a strong signal, adjusting the VFO slowly until the signal strength is centered in the filter, as you did above.
- Turn on the sidetone again using the **STP** menu entry.
- Adjust C20 so that the pitch of the received signal matches your sidetone pitch. This is best done with both the received signal and sidetone at about the same amplitude. The received signal will seem to "disappear under" or "merge with" the sidetone when the pitch is closely matched.
- Tap **MENU** twice to return to normal operation.

Operating Frequency Calibration

The operating frequency display may be off by up to 10 kHz until calibrated, due mostly to variations in the crystals on the Filter board. Accuracy of +/- 100 Hz can be obtained.

Note: The approximate lower band edges in MHz are as follows: 3.50, 7.00, 10.00 or 10.10 (selected earlier), 14.00, 18.05, 21.00.

Select the lower-frequency band using **BAND**. Also select the narrowest filter (**FL3**) by holding **XFIL**.

Tune in a signal at a known frequency, centering the signal in the crystal filter passband. Use a signal from a known-accurate signal generator, or check the signal's frequency using a second receiver.

To access the operating frequency calibration display, locate **CAL** in the menu, then hold **EDIT**. You'll see **OPF** briefly, then the operating frequency will be shown, with the 100-Hz digit flashing. (If you see **E42**, the VFO is not functioning.)

Tap **WPM+** or **WPM-** until the displayed frequency matches the frequency of the known signal. In the case of the internally-generated signal, tap **WPM+** or **WPM-** until the display reads **99.7**.

Tap **MENU** twice to return to the normal display.

Tap **BAND** twice quickly to switch to band 2.

Repeat the calibration procedure on this band. If you have a 4-band Filter board installed, repeat the procedure for bands 3 and 4.



You can calibrate the dial on transmit rather than receive if desired, after completing Alignment and Test, Part II. In this case you'll need either a frequency counter or a calibrated ham-band receiver to verify the actual transmit frequency. You'll then use the **CAL** menu entry, as described above, to check and adjust the operating frequency after each transmission.

AGC (Automatic Gain Control) and S-Meter Test

Turn the K1 on and connect an antenna or signal generator.

S-meter display mode provides a bar graph to indicate approximate received signal strength. To select this mode, hold **DISPLAY**. You should see a brief bar-graph test pattern, then the display may go blank or show one or more bars.

Tune in a strong signal. (Anytime you are actually moving the VFO, the S-meter bargraph will be replaced with the frequency display.) Once the signal is tune in, the AGC should be activated, as indicated by an increase S-meter reading.² The S-meter zero point and scale can be adjusted (page 53). AGC can also be turned off if necessary (page 57).

Note: Since the K1 uses audio-derived AGC, the initial code element from a very strong station may be heard at louder volume. This is due to the time it takes for the AGC detector capacitor to charge up. If this is objectionable, the attenuator can be used. Turning on the attenuator adds one bar to the S-meter reading to roughly compensate for the loss in signal strength.

Receive Current Drain Test (Optional)

Typical current drain for the K1 in receive mode is approximately 55 mA (with all LEDs off). If the current drain is significantly lower or higher than this, it could indicate a problem.

To check the current drain, set your DMM for DC milliamps and temporarily insert the DMM in series between the K1 and the power supply. Turn the K1 on and note the current: _____ mA.

This completes receiver alignment.

² Each bar corresponds to roughly two S-units, so that 4 or 5 bars indicates about an "S-9" signal.

8. RF Board, Part II

In this section you'll install the transmitter components.

Turn off the K1 and disconnect the power supply.

Unplug the Filter board and set it aside.



If you have difficulty installing components in the remaining assembly steps, unplug the Front Panel assembly and remove the side panels.

Install the following capacitors, starting with C3, which is in the back-left corner of the RF board.

<input type="checkbox"/> C3, 10 (10)	⇒	<input type="checkbox"/> C62, 330 (331)	⇒	<input type="checkbox"/> C56, .047 (473)
<input type="checkbox"/> C15, .001 (102)		<input type="checkbox"/> C58, .01 (103)		<input type="checkbox"/> C51, .001 (102)
<input type="checkbox"/> C14, .001 (102)		<input type="checkbox"/> C16, .001 (102)		<input type="checkbox"/> C60, .01 (103)
<input type="checkbox"/> C76, .01 (103)		<input type="checkbox"/> C57, .047 (473)		<input type="checkbox"/> C47, .01 (103)
<input type="checkbox"/> C44, .01 (103)		<input type="checkbox"/> C46, 0.1 (104)		<input type="checkbox"/> C50, .047 (473)
<input type="checkbox"/> C55, 0.1 (104)		<input type="checkbox"/> C52, 0.1 (104)		<input type="checkbox"/> C43, .01 (103)

Install the following 5% resistors, starting with R35 on the left side of the board near J6.

<input type="checkbox"/> R35, 120 (BRN-RED-BRN)	⇒	<input type="checkbox"/> R10, 470 (YEL-VIO-BRN)
<input type="checkbox"/> R11, 82 (GRAY-RED-BLK)		<input type="checkbox"/> R22, 33 (ORG-ORG-BLK)
<input type="checkbox"/> R12, 820 (GRAY-RED-BRN)		<input type="checkbox"/> R24, 2.7 k (RED-VIO-RED)
<input type="checkbox"/> R38, 270 (RED-VIO-BRN)		<input type="checkbox"/> R28, 820 (GRAY-RED-BRN)
<input type="checkbox"/> R29, 270 (RED-VIO-BRN)		<input type="checkbox"/> R30, 3.3 Ω (ORG-ORG-GOLD)
<input type="checkbox"/> R33, 470 (YEL-VIO-BRN)		<input type="checkbox"/> R25, 100 k (BRN-BLK-YEL)
<input type="checkbox"/> R31, 33 (ORG-ORG-BLK)		<input type="checkbox"/> R32, 33 (ORG-ORG-BLK)

On the bottom of the board near the antenna jack, install a 1.50 k, 1% resistor at R36 (BRN-GRN-BLK-BRN), and a 226-ohm, 1% resistor at R37 (RED-RED-BLU-BLK).



Be sure to check the orientation of the banded end of each diode in the following steps.

Install the 36-volt zener diode, D19 (type 1N4753), which has a large glass or silver-colored body. D19 is on the right side of the board, between transformers T3 and T4 (not yet installed).

The remaining diodes to be installed are all type 1N4007. D18 is on the left side of the board, near J6.

D18 D14 D13 D9

Install a 100-μH RF choke (BRN-BLK-BRN) at RFC3 (located near S1).

Install 22-μH RF chokes (RED-RED-BLK) at RFC2 and RFC5.

Refer to Figure 5-4 (page 19) when installing these transistors.

Q5, J309 (near J6) Q14, 2N4124 (back-left corner)

Install C1 (150 pF, “151”) on the bottom of the board. Before soldering, fold C1 down towards the pads of R31 and R32 (but make sure it isn't touching these pads). C1's overall height should be no more than 0.15” (4 mm) above the bottom of the board.

 TO-220 package transistors Q6 and Q7 look identical, but are different types. Locate the 2SC1969 (labeled "C1969"), Q7, and set it aside. The remaining transistor, Q6, will be either a 2SC2166 (C2166) or a 2SC5739 (C5739). This transistor will be installed first.

Attach a self-adhesive thermal pad to the PC board on top of the component outline for Q6. The hole in the thermal pad must be aligned precisely with Q6's mounting hole on the board.

Prepare the leads of Q6 as shown below, bending them downwards to match their pads. To avoid stressing the leads, use smooth bends, rolling them over a small screwdriver blade or forming them using long-nose pliers.

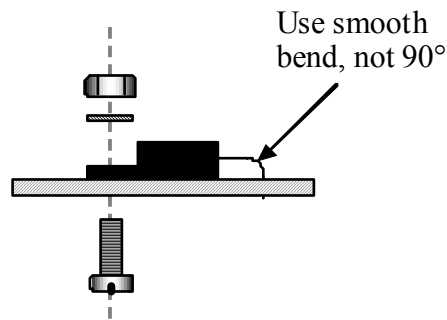

Figure 8-1

Secure Q6 to the board using a 4-40 x 3/8" (9.5 mm) pan-head screw (shiny finish, not black), #4 internal-tooth lock washer, and 4-40 nut. The screw should be inserted from the bottom side (Figure 8-1).

Verify the part number on Q6 (2SC2166, C2166 or 2SC2166, C2166), then solder. Trim the pins on the bottom.

Remove the right side panel if it is still attached.

Identify the hole in the right side panel where the thermal insulator will be placed (Figure 8-2). If the edge of the hole is not completely smooth, use a large drill bit to de-burr the hole by hand. Follow with a small amount of light sanding of the indicated area.

Attach a self-adhesive thermal pad to the side panel at the location shown in Figure 8-2. The hole in the thermal pad must be aligned precisely with the hole in the panel. The pad must be straight, not tilted or skewed in either direction.

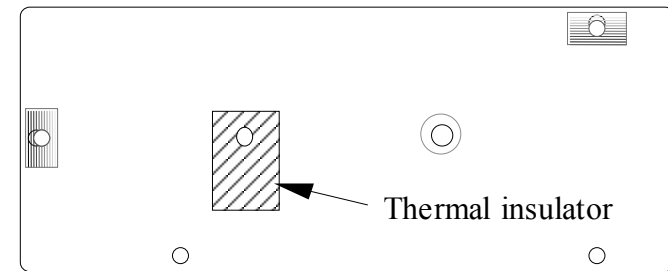

Figure 8-2

Attach Q7 to the right side panel using the hardware shown in Figure 8-3: a 5/16" (8 mm) x 4-40 flat-head screw, shoulder washer (black plastic), #4 internal-tooth lock washer, and 4-40 nut. **The small-diameter part of the shoulder washer must be inserted into the hole in Q7's tab. Do not over-tighten the hardware.**

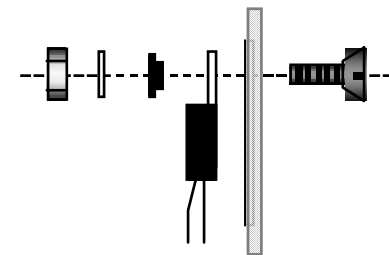

Figure 8-3

- Bend the center lead of Q7 slightly away from the side panel, forming it as shown in Figure 8-3.
- Hold the right side panel up to the right edge of the RF board. Insert Q7's leads into their pads while guiding the panel into position. Secure the right side panel to the RF board using two 3/16" (4.8 mm) flat-head screws.
- Solder and trim the leads of Q7 on the bottom of the board.
- Using an ohmmeter on a low resistance scale, check for a short from Q7's tab to ground. (The tab is connected to the collector lead.) The metal hardware used to hold Q7 to the side panel may show low resistance to ground, but the tab should be floating (> 1 k).
- Install 8-pin ICs U8 (SA602 or SA612AN) and U9 (LT1252). Orient the ICs as indicated by their component outlines.



Toroidal transformers T3 and T4 must be wound exactly as described in the following steps. Recall that transformer windings are identified by numbered pairs of leads, which correspond to the numbered PC board pads.

- T3 is wound on an FT37-43 core (dark gray), the smaller of the two cores remaining. Start with the 1-2 winding, which uses 12 turns of red enamel wire (9", 22 cm). See Figure 8-4.

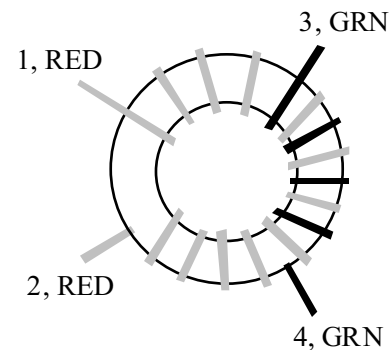



Figure 8-4

- T3's 3-4 winding uses 4 turns of green enamel wire (6", 16 cm). The turns of the 3-4 winding must be tightly interlaced with the 1-2 winding as shown in Figure 8-4.
- Strip and tin T3's leads.
- Install T3 flat against the PC board, to the right of Q6. Pull the leads taut on the bottom side before soldering.

 T4 uses a *bi-filar* winding, which means that two wires are wound on the core together. The wires for the two windings will be twisted together (see Figure 8-5).

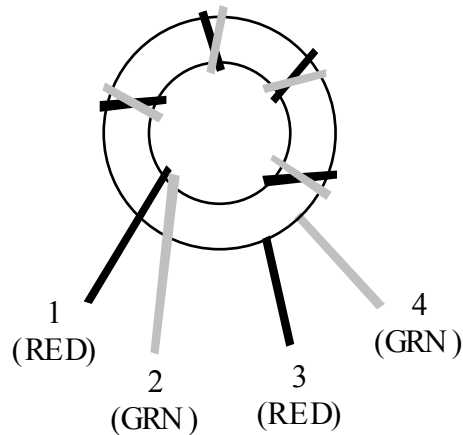

Figure 8-5

- Cut two 8" (20 cm) lengths of enamel wire, one red and one green. Twist the wires together over their entire length. The wires should cross over each other approximately every 1/2" (1 cm).
- Wind the twisted wires onto the 1/2" (12.7 mm) dia. ferrite core (FT50-43, dark gray), using 5 turns and covering about 85% of the core. Figure 8-5 shows how the winding should look.
- Separate T4's leads as shown in Figure 8-5. Strip and tin the leads. Be careful not to let the red and green wires short together.
- Install T4 flat against the PC board as indicated by its outline.
- Using your DMM on a low resistance scale, measure continuity between the #1 and #2 pads of T3. If you get a reading over 5 ohms, re-strip the affected lead(s). Similarly, check the 3-4 winding of T3. Then check T4's 1-3 and 2-4 windings.

If you plan to operate the K1 on 80 meters, and your K1 RF board is revision D or earlier, you may need to make a minor modification to the PC board. Please refer to the errata sheet included with the K1B80 (80-m Band Kit).

Uninstalled Components

Make sure that all component locations on the RF board have been filled, except for two: J1, which is supplied with the noise blanker option kit (KNB1), and C78, which may be supplied with the 80-m band kit for the 2-band Filter board. If you have the 80 meter board, install C78 at this time on the bottom of the board near the PA and 12V labels with the (+) lead oriented as shown on the outline. Fold C78 down flat against the board before soldering.

Visual Inspection

Examine the bottom (solder side) of the RF board carefully for unsoldered pins, solder bridges, or cold solder joints.

Resistance Checks

For the following measurements, connect the (-) lead of your DMM to a ground jumper. When making measurements at J7 and J8, use a component lead or hookup wire as a probe tip.

Test Points (+)	Resistance
J7 pin 1	2.4-3.0 k
J7 pin 4	> 1 k
J7 pin 5	> 100 k
J7 pin 6	5 - 7 k
J7 pin 8	1.5-2.0 k
J8 pin 1	> 100 k
J8 pin 5	90-110 k
J8 pin 7	1.6-1.9 k
U4 pin 7	> 1 k
U8 pin 8	> 100 ohms
U9 pin 7	> 1 k
D9 cathode (banded end)	1.5-2.0 k
D9 anode	> 100 ohms

9. Alignment and Test, Part II

In this section you'll align and test the transmitter stages.

- Attach the side panels, then plug in the Front Panel assembly.
- Make sure the Filter board is **not** installed.
- Place the power switch, S1, in the OFF position (out).
- Connect a 12 to 14-V, 1-amp power supply (or battery) to J4.
- Turn on the K1. You should see **E27** on the LCD due to the missing Filter board. Tap any switch to clear the message.
- Place the transmitter in TUNE mode (key-down), by holding the **WPM+** and **WPM-** switches simultaneously. The display should show **0.1** watts, even though actual power output is zero.
- Make the following transmit-mode DC voltage measurements. Connect the (-) lead of the DMM to a ground jumper. **Note:** The banded end of diodes is the cathode.

Test Point	DC Voltage	Test Point	DC Voltage
J7 pin 1	5.1-6.7	D9 anode	4.3-4.6
J7 pin 4	5.9-6.1	D9 cathode	3.8-4.1
J7 pin 6	< 0.2	D10 anode	< 0.2
J7 pin 8	3.8-4.1	D10 cathode	3.8-4.1
U8 pin 1	1.3-1.5	D11 anode	< 0.2
U8 pin 8	5.1-5.5	D11 cathode	4.0-4.6
U9 pin 3	6.0-7.0	D13 anode	0.6-0.7
U9 pin 6	6.0-7.0	D13 cathode	< 0.2
U9 pin 7	12-14		

- Turn off the K1. Plug in the Filter board.
- Connect an antenna that is adequate for receiver testing. Plug in a pair of stereo headphones or a speaker at J2.
- Turn on the K1 and test receive performance. If receiver gain seems to be too low, you may have an assembly error in the transmit stages or T-R switch. Remove the Filter board and re-check the orientation of all diodes, transistors, and ICs. Also look for shorts on both the top and bottom of the board in the transmitter area. (Also see Troubleshooting.)
- Switch to the voltmeter display to make sure that the battery or power supply voltage is not being pulled down when the K1 is turned on. (Hold **DISPLAY** once to select S-meter mode, and a second time to select voltmeter mode.)

Preparation for Transmit Alignment

- Turn the K1 off. Secure the Filter board to its three standoffs using 3/16" (4.8 mm) pan-head screws and #4 split lock washers.
- Connect a 50-ohm dummy load at the antenna jack. The dummy load should be rated at 5 watts or higher.
- Connect a key or keyer paddle.
- Turn the K1 on.
- Tap **MENU** and locate the **OUT** entry (power output level). Hold **EDIT**, then use **WPM+** and **WPM-** to set power to **2.0** watts.

Band 1 Alignment

If a 4-band Filter board is in use, refer to the KFL1-4 manual, page 19.

All filters are shared between receiver and transmitter, so transmit alignment should already be close. However, it's important to re-peak the filters on transmit. An analog wattmeter, ham-band receiver, or the K1's built-in digital wattmeter can be used.

Switch to lower-frequency band using **BAND**. Set the VFO to approximately the middle of the desired band.

Refer Figure 7-2 to identify the band 1 inductors.



The K1 can be placed in TUNE mode by holding the **WPM+** and **WPM-** switches together. During TUNE, the power in watts will be shown on the LCD (e.g., **P2.0**). Hitting the key or pressing any switch except **WPM+** and **WPM-** will cancel TUNE.

Put the K1 into TUNE mode. Using the alignment tool, adjust L1, L2, L5 and L6 for maximum output. *If the output jumps up to well above 2 watts, exit TUNE mode, then re-enter it again.*³

If necessary, repeat the adjustment of the filters two or three times to be sure that you have the inductors peaked correctly. If output is < 2 w or is not stable, see Troubleshooting.

If possible, verify that the K1 is transmitting on the correct frequency using an external ham-band receiver. Connect a short length of wire to the receiver's antenna jack. (*Do not connect the K1 directly to the receiver.*) Key the K1 and locate the signal.

To make sure that the filters are peaked at the correct frequency, vary each inductor a small amount while observing the receiver's S-meter.

³ The transmitter's ALC (automatic level control) attempts to set the power you specify. ALC is activated for 1-2 seconds when you enter TUNE mode. After that, it is "open-loop," allowing you to adjust the filters. If the power jumps, re-starting TUNE mode will activate the ALC again, reducing the drive back down to the level needed to stay at about 2 watts.

Band 2 Alignment

Switch to band 2, and set the VFO to about mid-band.

Put the K1 into TUNE mode and adjust L3, L4, L7, and L8 for maximum output (refer to Figure 7-2 if necessary).

Verify that the K1 is transmitting at the intended frequency.

5-watt Test

Set power output to **5.0** watts using the **OUT** menu entry.

Enter TUNE mode briefly. The wattmeter should display approximately 5 watts. Test 5-watt output on both bands.

Transmit Offset Adjustment

Locate the offset test switch (S2) on the bottom of the RF board. Place it in the TEST position. You should hear a tone in the headphones; its pitch is equal to the transmit offset. If you don't hear a tone, try rotating C13 (back left corner, near the key jack).

Using the menu, locate **STP** (sidetone pitch), and go into edit mode to turn on the sidetone. You should now hear *two* tones: the sidetone and the transmit offset tone. If the sidetone is very weak or very strong compared to the transmit offset tone, use the **STL** menu entry to adjust the sidetone volume. **Note:** The receiver is muted in **STL** edit mode, so you'll have to return to **STP** after making any change to the sidetone setting.

Adjust C13 so that the transmit offset pitch is as close as possible to your selected sidetone pitch. The two will seem to "merge" when the pitches are matched.

Exit the menu, and set S2 back to the OPER position.

If necessary, use the **CAL** menu entry to calibrate the operating frequency on transmit (see page 41).

This completes transmitter alignment.

1. Final Assembly

- Remove any masking tape from the top and bottom covers. Use the technique described on page 23.
- Remove and save the hardware supplied with the antenna and key jacks.
- The components on the bottom of the board must have an overall height of no more than about 0.2" (5 mm) above the PC board. Fold down or re-solder components if necessary.
- Install the bottom cover by sliding it over the rear-panel controls. Secure it to the rest of the assembly using six 3/16" (4.8 mm) pan-head screws.
- Install the hardware supplied with the antenna and key jacks. Be careful not to strip the plastic threads on the antenna jack.

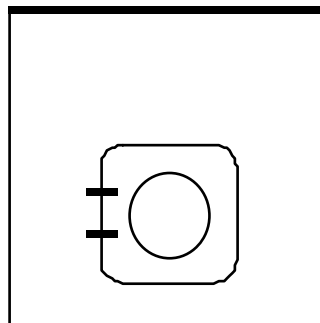

Figure 10-1

- Set the top cover *upside-down* in front of you, with the back edge facing away. Place the speaker over its holes, with the lugs to the *left*. (Figure 10-1) .
- Trim the speaker grille cloth so it is the same size as the speaker frame and then trim the corners so it fits between the fiber washers. Keep the grille cloth in place as you secure the speaker to the top cover using four 5/16" (8 mm) flat-head screws, #4 fiber washers (black), #4 metal flat washers, #4 internal-tooth lock washers, and 4-40 nuts (Figure 10-2). The fiber washers go between the speaker and the top cover. **Do not over-tighten the nuts, as this can flex the speaker frame, causing damage to the speaker and/or distorted audio.**

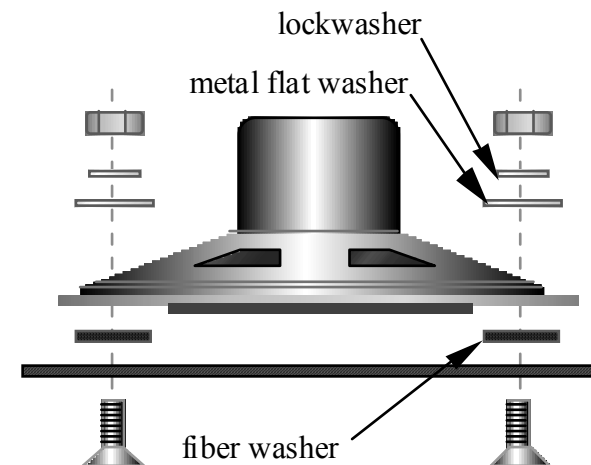

Figure 10-2

- Cut a 5" (13 cm) length of two-conductor speaker cable. Remove 1/4" (6 mm) of insulation from the wires at both ends.
- Solder crimp pins to the two wires at one end (Figure 10-3).

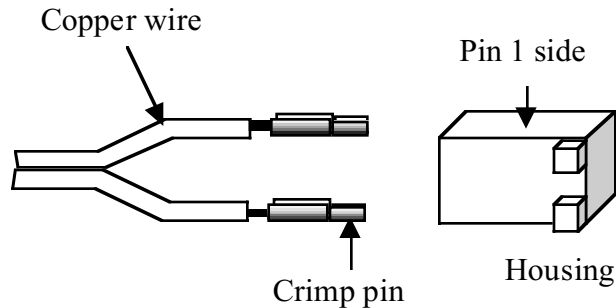

Figure 10-3

i When you insert the crimp pins into the housing in the next step, they should snap into place. Each pin has a small tab on the back that latches into a hole in the housing when inserted.

- Insert the copper wire into the pin 1 position of a two-pin housing as shown. Insert the other wire into the pin 2 position.
- Connect the other end of this cable to the speaker terminals. The copper wire should be connected to the lug marked (+) on the speaker. Solder both wires.
- If there are any missing chassis screws in the bottom cover, side panels, or front panel, install them now.

- Plug the internal speaker cable into P2 on the RF board. The connector is keyed and can only be plugged in one way.

i When you install the top cover in the next step, route the speaker cable along the right side of the cabinet, away from the pins of the microcontroller (front panel, U1). The speaker wire could pick up signals from the microcontroller, causing receiver interference.

- Place the top cover onto the chassis. Secure the top cover using *two pan-head* and *two flat-head* 3/16 (4.8 mm) screws.
- Four self-adhesive feet are supplied for the bottom cover. Install one at each corner, approximately 1/4" (6 mm) from edges.
- Attach the self-adhesive serial number label to the rear panel of the bottom cover in the space provided.
- Write the serial number on the inside cover of your manual.
- If you have the KTS1 wide-range tilt-stand, you should configure it for desk-top use (using the short arms) and attach it to the K1 at this time. Refer to the KTS1 instructions.

This completes assembly of your K1 Transceiver. You should have a number of washers, screws, and other hardware left over. These items have been provided as spares. Please read the Operation section, which follows, and try each of the K1's features. If you're new to QRP, be sure to read the QRP Operating Tips (page 56).

i If you have purchased K1 internal options, we recommend that you do not install them until becoming familiar with basic K1 operation. Once you're ready to build option kits, the suggested order of assembly is: **KFL1-2 or KFL1-4, KAT1, KNB1, KBT1.** (All K1 options are described on page 57.)

11. Operation

This section explains how to set up and operate the K1. We suggest you read the first few pages as an overview, then follow the tutorial, which starts on page 54 (Basic K1 Operation). There's also a **Quick Reference**, Appendix G, which shows the locations of front-panel controls and describes each of the menu entries.

Connections

Power Supply

You can use any 9-15 V DC power supply; current drain is about 0.5-1A on transmit. A mating DC power connector is provided with the kit. **Use an in-line 2A fuse when operating from a battery or power supply that does not include its own fuse.**

Low Battery warnings: If your battery (or power supply) voltage drops below about 9 V, you'll see a brief **BAT LO** message flashed on the LCD once every 5 minutes (approx.). This voltage level was chosen to be compatible with an 8-cell NiMH or NiCd battery back. **Other battery types may have a different end-of-life voltage; check the voltage using BAT display mode often. 12-V gel-cell batteries must be recharged at 10.5-11.0 V.**

Headphones or External Speaker

The front-panel headphone jack can accommodate either headphones or an external speaker, with an impedance of 8 ohms or higher. **A stereo plug or mono/stereo adapter is required, unless you modify the RF board (see 2nd step on page 31).**

Keying Device

Any type of hand key, bug, or external keyer can be plugged into the KEY jack, or you can connect a paddle and use the K1's built-in memory keyer. In all cases, you must use a stereo plug with the keying device (a suitable plug is provided with the kit). It is also possible to connect both a keyer paddle and another keying device at the same time; see Keying Device Selection (page 55).

Antenna

Any well-matched, unbalanced (usually coax-fed) antenna can be used with the K1. With non-resonant antennas or balanced feedlines a suitable balun and/or antenna tuner will be required. If you have the KAT1 automatic antenna tuner option installed, you can connect a wide range of random length or non-resonant antennas directly to the K1 and use them on one or more bands.

Power setting accuracy with internal RF detector: Power readings using the K1's built-in RF detector (D15) are only accurate when the SWR is low. If you use a poorly-matched load, you should check your power output with an external wattmeter. In some cases a high-SWR load can result in excessive current drain.

Power setting accuracy with KAT1: If you have the KAT1 installed, power output display will be much more accurate under all SWR conditions, since the tuner provides its own calibrated SWR bridge/wattmeter.

Controls and Display

LCD

The 3-digit LCD (liquid crystal display) shows the operating frequency or relative signal strength (S-meter) on receive, power output on transmit, menu parameters, and status information.

Decimal Point: The decimal point is flashed when RIT or XIT is enabled. This acts as a reminder that RIT or XIT is on.

Error Messages: If a problem is detected on power-up or during normal operation, the display may show **E42** or a similar message. If this happens, see Troubleshooting.

LEDs

RIT/XIT (dual-color): RIT (green) or XIT (orange)
ATTN: Attenuator (yellow)

Note: The LEDs can be disabled using the **LED** menu entry. This can save up to about 20 mA of receive-mode current drain.

VFO

The VFO covers about 80 or 150 kHz of each CW band, as selected during assembly. The approximate lower band edges in MHz are: 3.50, 7.00, 10.00 or 10.10, 14.00, 18.05, and 21.00.

Potentiometers

AF GAIN: Sets the receive audio output level. It also affects the sidetone volume, in conjunction with the STL menu entry. **Note:** The gain setting for headphones will be lower than for the speaker.

OFFSET: Adjusts the offset when **RIT** or **XIT** is turned on. The range is about +/- 3 kHz. (The range is set by RF-C7.)

Switch Functions

TAP a switch to access its upper function; **HOLD** a switch for 1/2 second to access its lower function. All functions are listed below.

The "1" and "2" labels near **WPM+** and **WPM-** correspond to CW message buffers 1 and 2 (see **MSG** and **REC**, below). The "T" label near these switches is a reminder that TUNE mode is activated by holding both **WPM+** and **WPM-** simultaneously (see page 54).

TAP and **HOLD** Switch Functions

BAND show present band/freq.; tap twice to change bands
DISPLAY select display mode (normal, S-meter, or battery)

MENU enter the menu (see Menu)
EDIT edit current menu parameter

RIT turn RIT on or off
XIT [PFn] turn XIT on or off, or select **PFn** (see Menu)

WPM+ increment keyer speed or menu parameter
XFIL select next crystal filter (FL1-3)

WPM- decrement keyer speed or menu parameter
ATTN attenuator on/off

MSG play CW message **1** or **2** (to repeat, hold **1** or **2**)
REC record CW message **1** or **2** (**MSG** cancels record)

Fast-Tap

If you tap **WPM+** or **WPM-** two or more times quickly, the keyer speed will change by two WPM at a time. In the **OUT** menu entry, fast-tapping will change the power in 0.5-watt steps.

Using the Menu

To access the menu, tap **MENU**. Scroll menu entries by tapping **WPM+** / **WPM-**.

Hold **EDIT** to display a menu entry's *parameter*, which can then be changed by tapping **WPM+** / **WPM-**. Tap **MENU** to return to scrolling. Another tap of **MENU** will return you to normal operation. If a parameter appears as "--", the associated option is not installed.

Edit Shortcut: If the menu entry you want is the last one you accessed, you can jump directly into edit mode by holding **EDIT**. After editing, exit by holding **EDIT** once more. **Note:** The AGC and NB parameters are not saved. On power-up, AGC is ON, and NB is OFF.

All menu entries are listed below. They are arranged so that the ones used most often are at the beginning and end of the list, allowing you to get to them quickly by scrolling forwards or backwards. The **FLx**, **Bx**, **CAL**, and **SIG** entries are described under Calibration Functions.

OUT	power output level: 0.1-7.0 watts (hold DISPLAY to select P=0 , for keyer/msg test)	LED	RIT/XIT/ATTN LEDs ON or OFF (hold DISPLAY to turn switch audio tones on/off ⁴)
STL	sidetone level (volume): 0-31	FLx	crystal filter bandwidth, 200-850 Hz (hold XFIL to select FL 1/2/3 , then tap WPM+ / WPM- to set bandwidth)
STP	sidetone pitch: 400 to 800 Hz in 10 Hz steps (can also be used to SPOT, since RX is not muted)	Bx	band assignments, in MHz (1.8 to 28.0) (tap BAND to select B1 through B4 ; on 30 m, hold DISPLAY to select 10.0 or 10.1)
T-R	transmit-receive (QSK) delay: 0 to 900 ms (50 ms recommended for casual operation)	CAL	operating frequency cal (OPF), per-band (hold DISPLAY to select OSC for VFO test)
RPT	CW message repeat interval: 0 to 255 seconds	SIG	S-meter zero set: Lxx , where xx = 30-70 (hold DISPLAY for scale: Hx , where x = 2-6)
INP	CW input device selection: Hnd (hand key or external keying device) PDn (internal keyer, paddles normal) PDr (internal keyer, paddles reversed)	NB	noise blanker mode: OFF , HI , LO
IAB	iambic mode: A or B	ATU	automatic antenna tuner mode (see KAT1 manual)
AGC	AGC ON or OFF ; no S-meter if OFF	PFn	programmable function (PFn) assignment; sets up XIT [PFn] switch as a shortcut to a selected menu entry. Set to NOR (normal) to use XIT.

⁴ Tones are only available on the RIT, XIT, and ATTN switches; they are useful when you have the LEDs turned off. When you hold **DISPLAY**, the menu parameter will flash **AF** if tones are enabled and **NOR** if disabled.

Calibration Functions

The **FLx**, **Bx**, **CAL**, and **SIG** menu entries are typically used during initial test and setup of the K1. **Bx** and **CAL** are also used whenever you plug in a different Filter module to allow the K1 to display the correct frequencies.

Crystal Filter Bandwidth Selection (FLx)

The K1 provides three crystal filter bandwidths, FL1, 2, and 3, which are selected using **XFIL** during normal operation. By default, the filters are set to about 800, 400, and 250 Hz. You can change these settings using the **FLx** menu entry.

To modify the bandwidth for a particular filter, enter the menu and scroll to **FLx** (where x is **1**, **2**, or **3**). Use **XFIL** to change the menu entry to the desired filter. Hold **EDIT**, then tap **WPM+**/**WPM-** to select one of the available bandwidths, in Hz. The bandwidth settings are approximate.

The BFO is not programmable. One setting of C20 on the RF board is used for all filters (see page 40).

Band Assignment (Bx)

This menu entry is used to tell the K1 firmware what bands your Filter board covers, allowing the **BAND** switch and VFO to display the correct frequencies. You should set up **B1** and **B2** (as well as **B3** and **B4** if applicable), then do VFO calibration using **CAL**.

The **Bx** parameter can be set to any band from **1.8** to **28.0** MHz, corresponding to the components on the Filter board. Some of these bands may not be available from Elecraft, but can still be used if you obtain the necessary components.

On 30 meters, you have a choice of two different band edges, corresponding to your selected VFO range (see page 12). Hold **DISPLAY** to select either **10.0** or **10.1** MHz.

Operating Frequency Calibration and VFO Test (CAL)

This menu entry is used to calibrate the operating frequency display, or to align the VFO. (VFO test and alignment is covered in detail on page 38.)

To calibrate the operating frequency: Switch to the band to be calibrated and tune in a signal at a known frequency. Then select **CAL** in the menu and hold **EDIT**. You'll see **OPF** briefly, then the operating frequency will be displayed to 100 Hz. The last digit flashes as a reminder that you're in calibration mode. Use **WPM+** and **WPM-** to set the reading to match the known frequency.

Note: Each band must be set independently since they use different crystals on the Filter board.

To check the range of the VFO: After holding **EDIT**, hold **DISPLAY** to switch to **OSC**. The display will then show you the MHz and kHz portion of the VFO frequency, alternating about once per second. Turn the VFO pot all the way in both directions to check the range. Holding **DISPLAY** again will switch back to **OPF** (operating frequency calibration display).

S-Meter Calibration (SIG)

To check the S-meter zero setting, use **DISPLAY** to switch to S-meter mode, make sure the attenuator is OFF, and disconnect the antenna. With no signal, the S-meter should indicate 0 bars, or the first bar may just be flickering on. If not, you can use the **SIG** menu entry to change the **Lxx** parameter. After each change to **Lxx**, hold **EDIT** to exit the menu and return to the S-meter display to see the effect on the S-meter reading.

To check the S-meter full-scale setting, re-connect the antenna and tune in a very strong signal. If the S-meter's reading appears to be too low or too high for the given signal strength, use the **SIG** menu entry to change the **Hx** parameter. (To get to the **Hx** parameter, hold **DISPLAY** while the **Lxx** parameter is displayed.) Reducing the **Hx** parameter value will increase the S-meter reading.

Basic K1 Operation

Self-Test: A number of tests are done at power-up. If you see an error message (such as **E42**), refer to Troubleshooting.

Band and Frequency Display: When you turn on the K1 or tap **BAND**, the current band and operating frequency will be displayed. For example, if the last band used was 40 meters and the VFO was set to 7025.3 kHz, the LCD would show **7**, then **025**, and finally **25.3**.

Changing Bands: To change bands, tap **BAND** quickly two or more times.

Receiver Setup

Display Mode: Holding **DISPLAY** alternates between three receive-mode displays: **frequency** (default), **S-meter**, and **voltmeter**. For normal operation, use frequency or S-meter mode. (In S-meter mode, the frequency is re-displayed automatically whenever the VFO is moved.)

AF GAIN: Adjust the AF GAIN control for comfortable headphone or speaker volume. The sidetone volume can be set higher or lower in relation to receiver audio using the **STL** menu entry.

Crystal Filter Selection: Filter FL1 (usually the widest filter) is selected on power-up. Holding **XFIL** cycles through the filters. Use narrower filters to reduce interference from nearby stations.

Attenuator: Holding **ATTN** switches in about 14 dB of attenuation. This may be useful if extremely strong signals are causing receiver overload. The receiver has sufficient sensitivity to allow the attenuator to be left in at all times, if necessary. If you turn the attenuator on when the display is in S-meter mode, an extra bar is added to the S-meter display to compensate. (Note: You can disable LEDs to save current using the **LED** menu entry.)

Transmitter Setup

Display Mode: During transmit the LCD normally shows a bargraph (1 bar per watt). If you select supply voltage display mode (using **DISPLAY**), the power supply or battery voltage will be shown, flashing slowly. In TUNE mode, power is shown in watts (see below). SWR can be displayed if the KAT1 ATU is installed.

Setting Power Output: Approximate power output can be set using the **OUT** menu entry (**0.1** to **7.0** watts). Anytime you change the power level or change bands, you'll see power start out near zero, then go up while you send the first few characters of CW. This is due to the transmitter's ALC (automatic level control). **Caution:** When working into non-50-ohm loads, the power display may not be accurate.

TUNE Mode: To put the transmitter into TUNE mode (key-down), press the **WPM+** and **WPM-** switches simultaneously. At 5 watts, the display would show **P5.0**. (It is normal for this number to vary over as much as several tenths of a watt.) While in TUNE mode, you can change power output using **WPM+** and **WPM-**.

Keyer Test Mode: It is possible to completely disable the transmitter to do keyer or message buffer testing (page 55).

QSK Delay and Sidetone: The QSK delay is set with the **T-R** menu entry. Sidetone volume and pitch are set using the **STL** and **STP** menu entries, respectively.

Transmit Offset: The transmit offset should be matched to your selected sidetone pitch using C13 on the RF board. This is normally accomplished during alignment (page 47).

Transmit Frequency Limits: Some countries require transmit to be disabled outside of specified amateur bands. Your K1 may include such limits encoded in firmware. In this case, if you key the transmitter with the VFO set outside the usable range, you'll see **End** on the LCD.

RIT and XIT

RIT (receive incremental tuning) can be used to fine-tune the pitch of a received signal without affecting your transmit frequency. This is most often used when a station calls you off frequency. To turn on RIT, tap **RIT**. The RIT LED (green) will turn on, and the LCD's decimal point will flash slowly. You can then use the **OFFSET** control to vary the receive frequency.

XIT works similarly to RIT, except that the *transmit* frequency is varied with the offset control. For example, suppose a DX station says to call "up". First, turn on **RIT** and use the **OFFSET** control to find a clear spot above the DX station's frequency. Then turn on XIT by holding **XIT [PFn]**.⁵ The XIT LED (orange) will turn on. If you need to determine the transmit frequency when using XIT, briefly turn on **RIT**, then switch back to **XIT**.

OFFSET Range: The range of the **OFFSET** control is determined by the value of C7, in the VFO area of the RF board. A larger or smaller value of C7 will increase or decrease the **OFFSET** range, respectively.

Keying Device Selection

A single connector in the back is provided for your keyer paddle, hand key, keyer, or computer. You must use a *stereo* (2-circuit) plug, even if you use only a hand key or external keyer. This should not affect the use of the keying device with other equipment, since the middle contact on the plug (often called the "ring" contact) is only used with keyer paddles.

Hand key or External Keying Device: To use a hand key, external keyer, computer, or external keying device, set **INP** to **Hnd** using the menu. You can key the K1 externally at up to 70 WPM. Note: The K1's message memories can only be programmed using a directly-connected keyer paddle.

Internal Keyer: To use a keyer paddle, use the menu to set **INP** to **PDn** or **PDr** (normal or reverse paddle). With **PDn** selected, the "tip" contact on the stereo key jack is DOT and "ring" (the middle contact) is DASH. **PDr** is the reverse.

Keyer Setup

Keyer Speed: Use the **WPM+** and **WPM-** switches to select the desired CW speed. The display will show the speed in WPM. Tapping either switch quickly two or more times will cause the speed to jump in 2 WPM increments.

Iambic Mode Selection: If you use a keyer paddle with two mechanically-independent levers, you can use *iambic* keying, meaning that both the DOT and DASH paddles can be pressed at the same time to generate a repeating DOT-DASH or DASH-DOT pattern. With practice, this can improve sending efficiency. The **IAB** menu entry allows you to select from two Iambic modes: **A** or **B**. If you're not sure which to use, select mode A (the default) which has more forgiving timing characteristics. Mode **A** is similar to mode A of the Curtis keyer IC; mode **B** is similar to Super CMOS Keyer III mode B.

Keyer Test Mode

At times you may want to disable the transmitter completely so that you can practice recording messages or just sending code with the keyer. The K1 has a built-in Keyer Test mode for this.

To activate keyer test mode, first select the **OUT** menu entry and hold **EDIT** to display the power output level. Next, hold **DISPLAY**. The power output parameter will change to **P=0**, indicating that the transmitter is disabled. To restore the original power level setting, hold **DISPLAY** again.

Note: Turning power to the K1 off and back on cancels keyer test mode and restores the original power level.

⁵ If you have assigned the XIT [PFn] switch to another function using the PFn menu entry, you cannot use XIT.

Recording and Playing Messages

The K1 provides two CW message memories of 90 bytes each. *CW messages can only be recorded using a keyer paddle connected directly to the K1's key jack.* Set **INP** to **PDn** or **PDr**. Messages are stored in EEPROM, so they won't be lost when power is turned off.

To Record a Message: Hold **REC**, and when prompted with **1-2**, tap either **1** or **2**. The display will then show REC 90, indicating that 90 bytes of storage are available in this message buffer. This number will count down toward 0 as long as you are sending. Whenever you stop sending completely, up to two standard-length word spaces will be inserted. To stop recording, tap **MSG**. If you do this *before* starting to send, the original message contents will not be lost.

To Play a Message: Tap **MSG**, then select a message by tapping either **1** or **2**. Message play can be canceled at any time by hitting **MSG** again or by tapping the keyer paddle. You can also change the keyer speed while messages are playing, using **WPM+** and **WPM-** as usual.

Keyer Test Mode: To play back messages without transmitting, use keyer test mode (page 55). In this mode, you'll see **P=0** on the LCD during message play, rather than the transmit bargraph.

Using Auto-Repeat

Either message memory can be auto-repeated when played, which is useful when calling CQ on a quiet band or during contests. Sometimes a band will be open but will "sound" dead, simply because no one is calling CQ at that moment. This is a great time to let auto-repeat do the work.

To use Auto-Repeat: Tap **MSG** as usual, but then *hold* either **1** or **2**. The message will then play back continuously until you tap **MSG** again or hit your key or paddle. You'll see **RPT** on the display in-between message transmissions.

Setting the Auto-Repeat Interval: The length of the pause between messages during auto-repeat can be programmed using the **RPT** menu entry (**0-255** sec.). Long delays are useful for beacons.

Using RIT During Message Repeat: You can use RIT (if it is turned on) to listen above and below your receive frequency between calls. This is useful when stations call you off-frequency.

QRP Operating Tips

Antennas: When you're using low power, a good antenna and ground system can make a big difference. In general, antennas should be mounted as high off the ground as possible, and resonant or multi-element antennas will be the most effective. An excellent choice for light-weight, multi-band portable use is a long, end-fed wire, used in conjunction with two or more ground radials and an antenna tuner. There are many references on antennas available, including the *ARRL Antenna Handbook*.

QRP Frequencies: Low-power enthusiasts can be found at certain "watering holes" on each band, listed below (MHz). An asterisk (*) indicates European or alternative QRP frequencies.

80 m:	3.560	40 m:	7.040 (*7.030)
30 m:	10.106 (*10.116)	20 m:	14.060
17 m:	18.096	15 m:	21.060

Calling and Listening: Calling CQ with low power may be frustrating unless you have a good antenna. Usually, you'll spend far more time *listening*. Keep transmissions short, especially when working other QRP stations, which will often be at or even below the noise level. Narrower filters (< 500 Hz) and slower code speeds should be used when conditions are marginal.

Contests: Both general interest and QRP-only contests provide a great way to work new states or countries. The K1, with its low current drain and compact size, is particularly well-suited to outdoor events such as Field Day and QRP To The Field.

Advanced Operating Features

Programmable Function Switch (XIT [PFn])

By default, the **XIT [PFn]** switch turns XIT on and off. Alternatively, this switch can be set up as a direct edit shortcut to any menu entry. To program the switch function, enter the menu and scroll to **PFn**, then change the parameter to the desired menu entry. Setting it to **NOR** (normal) assigns the switch to XIT.

Spotting

The **STP** menu entry can be used to "spot," or match the pitch of received signals, so that you'll be exactly on frequency when you transmit. To spot a signal, select the **STP** menu entry, hold **EDIT**, then adjust the VFO until the received signal pitch matches the sidetone pitch. The received signal may seem to disappear when the pitch is exactly matched. You can assign **STP** to the programmable function switch if you don't use XIT (see above). **XIT [PFn]** will then activate the spot signal.

AGC Control

Some operators prefer to turn AGC off and use manual gain control under certain weak-signal conditions. To turn AGC off, use the **AGC** menu entry. The attenuator may help with strong signals.

Checking the Firmware Revision

Hold any switch on power-up to display the revision (e.g. **108**).

Resetting to Factory Defaults (requires rev. 108 or higher)

Reset to defaults takes two steps. **Step 1:** Hold **BAND** and **MENU** together on power-up, releasing the switches after the LED test. You should see **E09**. **Step 2:** Turn power off and back on again; you should see **E10**. You'll then need to re-do VFO calibration, etc.

K1 Options

Four- and Two-Band Filter Modules (KFL1-4, -2)

The KFL1-4 and KFL1-2 options provide additional bands of your choice, allowing you to select the best combination of bands for home use, field trips or specific operating events. The KFL1-4 includes 40, 30, 20, and either 17 or 15 meters.

Wide-Range Tilt Stand (KTS1)

When hiking or camping, you may find that there's no table or other smooth surface on which to operate a transceiver. The KTS1 solves this problem by allowing you to rest the K1 on nearly any rough surface (rock, dirt, etc.) and tilt the display upwards to the ideal viewing angle. It also keeps antenna and power connections away from the ground, and provides a mounting point for a keyer paddle. (Refer to our web site for information on custom paddles.)

Noise Blanker (KNB1)

The KNB1 is effective in reducing pulse-type noise, such as that from power poles or automobile ignition systems.

Automatic Antenna Tuner (KAT1)

If the KAT1 internal automatic antenna tuner is installed, you can connect coax-fed or random-length wire antennas directly to the K1. An inexpensive home-made balun can be used with balanced lines. In most cases the tuner will allow you to match one antenna on all bands. Once you've tuned up an antenna, the tuner's L and C settings will be recalled instantly when the band is changed.

Internal Battery (KBT1)

The KBT1 includes an 8-AA-cell socket and a replacement top cover with a quick-access battery door. Any cell type may be used.

12. Circuit Details

While reading this section, refer to the Block Diagram (Appendix B) and schematics (Appendix C).

Overview

The K1 is a compact, high-efficiency CW transceiver capable of operating over a wide range of frequencies. The two (or four) bands of operation are determined by a single plug-in filter module, allowing the builder to swap in a different set of bands if desired. The firmware will recognize whether a two- or four-band board is installed.

The filter module includes the band-pass filters and crystals for the K1's pre-mix conversion scheme, in which a low-frequency (~3 MHz) VFO is subtracted from a high-frequency crystal oscillator to produce a "pre-mixed" injection frequency for the transmit and receive mixers. Because of the VFO's low operating frequency, stability is excellent. An analog VFO is used, resulting in a lower noise floor than most synthesized transceivers. The filter board also has RF band-pass and low-pass filters for each band.

The receiver is a single-conversion superhet, using down-conversion to a low intermediate frequency (I.F.) of about 4.915 MHz. Down-conversion minimizes complexity and receive-chain noise, while the low I.F. allows good CW selectivity with a 4-pole crystal filter. The use of active mixers keeps current consumption low, compatible with portable operation.

There are three stages of transmitter amplification. Maximum power output from the final stage (class C) is about 5 to 7 watts, depending on the band and supply voltage. The T-R circuitry is all

solid-state (no relays), resulting in smooth, fast QSK.

A low-power microcontroller (MCU) on the front-panel board is used to control the transceiver and handle user interface elements, such as the display and switches. A second, smaller microcontroller, the I/O controller (IOC), acts as a driver for the filter and attenuator relays. The IOC is controlled by the main MCU via a one-line network, the *auxBus*. Option microcontrollers (i.e., on the noise blanker and antenna tuner) also communicate via the *auxBus*.

Front Panel Board

Microcontroller (MCU) U1 is used to control all K1 functions, and doubles as the driver for the LCD, DS1. U1 runs at just below 4 MHz. The crystal, X1, is intentionally kept under 4 MHz (by using large oscillator capacitors), so that any internally-generated band-edge signals will be below the bottom edge of the band.

The LCD segments are driven with 50% duty cycle square waves to ensure that the average DC voltage on each segment is 0 volts. The LCD backplane (pin 24) is also driven by a low-frequency square wave. To turn on a segment, it must be driven 180-degrees out of phase with the backplane. In-phase segments remain off.

The MCU has a number of miscellaneous functions. It reads the states of the switches (S1-S6) by periodically making the associated LCD drive lines into inputs. The VFO signal is amplified by Q1, then counted at MCU pin 6 (RA4). Pin 3 (RA1) is made an A-to-D (analog-to-digital) input to read the battery voltage, or an output to turn the ATTN LED on or off. Pin 4 (RA2) drives to 6 V or 0 V to turn on the RIT or XIT LEDs, respectively (both part of D1), by

virtue of an intermediate voltage supplied by op-amp U5A. To turn both elements of D1 off, pin 4 is made an input.

The states of the DOT and DASH lines are sampled on analog input RA3 (pin 5). If both DOT and DASH are open, the voltage at RA3 will be about 6 V. If both are closed, the voltage will be 0 V. If only one paddle is closed, an intermediate voltage results, either 2 V or 4 V. (See RF board, sheet 2.)

Q2 defeats the RIT/XIT offset when its gate voltage is at 6 V, since its low drain-source resistance forces a fixed 3 V to appear at the wiper of the offset pot, R3.

U2 and U3 are controlled by the SDA (data) and SCL (clock) lines, using the industry-standard I2C protocol. U2 is a dual-output D-to-A converter that controls the power level and generates audio tones. When tones are not being generated, the tone output is used to set the crystal filter bandwidth. U3 is a 512-byte EEPROM, which stores all K1 operating parameters and CW messages.

VFO pot R1 is physically part of the front panel assembly, but its wiper voltage (0-6 V) is routed to the RF board via J1. R19, located between the wiper and the high end of the pot, improves tuning linearity.

Filter Board

Note: This section applies to the 2-band filter module (KFL1-2). For details on the four-band module, refer to the KFL1-4 manual.

L1-L4 and associated capacitors form two band-pass filters, one for the premix signal on each band. There are also crystals for each band (X1, X2). For example, on 40 m (7.000 MHz), the pre-mixer (U7, RF board) mixes a 3.085-MHz signal from the VFO with a 15.000 MHz crystal oscillator to obtain a difference signal at 11.915 MHz. There is also a sum frequency, 18.085 MHz, which is rejected by the band-pass filter. The 11.915 MHz signal is routed to the RF board at P1 pin 6.

L5-L8 and associated capacitors form two RF bandpass filters, one for each band. T-R switching circuits on the RF board place these filters in either the receive or transmit path. L9-L12 and associated capacitors form the two low-pass filters.

All filters and the two crystals are switched by latching relays K1-K3. Microcontroller U1 pulses the relay coils bidirectionally to switch them on or off. The reset condition of each relay selects band 1. Latching relays are only energized when switched between set and reset, so they consume no power during normal operation.

RF Board

VFO (Sheet 1)

Q8 is used in a varactor-tuned Colpitts VFO. The VFO tunes "backward." For example, its frequency is about 3.080 MHz when the operating frequency is 7.000 MHz, and 2.930 MHz when the operating frequency is 7.150 MHz. This is due to the fact that the VFO is subtracted from the crystal oscillator in the pre-mixer (U7).

The use of varactor diodes (electronic tuning) results in a compromise between circuit complexity, tuning range, and stability. While VFO drift can never be eliminated entirely, steps were taken to minimize it.

First, the VFO supply voltage is double-regulated (explained in the next paragraph). This improves stability by guaranteeing a very stable voltage reference for the varactor diodes. Since the transmitter circuits run from a different regulator, and since the VFO is also well-buffered from the transmitter, there is virtually no VFO frequency shift or chirp on key down over the full power output range (0.1-7 watts). Second, temperature-compensation techniques are used in the VFO itself, including careful selection of capacitor types. The inductor used has a low temperature coefficient, and its turns are adjusted to select the desired range, which eliminates drift-prone trimmer capacitors.

Q9 isolates the VFO from noise pickup on the frequency counter line. U5 and U6 double-regulate the VFO supply voltage for improved stability. Since U5 is a low-dropout 8-volt regulator, the K1's supply voltage can drop to as low as about 8.5 V without affecting the VFO frequency. U6 is a 6.0-volt regulator with a very tight tolerance of 2.5%.

Premixer U7 mixes the VFO with one of the crystals on the Filter board.

Receiver (Sheet 1)

U1 is a double-balanced receive mixer, which provides an excellent noise figure at low current drain. If input levels are too high, an attenuator can be switched in via K1. RFC9 (across K1) suppresses attenuator on/off switching noise that might otherwise be audible.

Emitter-follower Q3 provides some power gain while providing a low driving impedance for the crystal filter (X1-X4). The crystal filter has variable bandwidth, by virtue of varactor diodes D6-D8. T2 steps up the crystal filter output to match the 1500-ohm input impedance of the product detector/BFO, U2. The BFO is mixed with the I.F. to produce an audio signal.

U3 amplifies the audio signal enough to drive the audio-derived AGC detector, D2. R21 and C18 remove high-frequency hiss.

D2 is DC-biased just below the level needed to turn on darlington transistor Q2. When a signal is present, Q2 will turn on in proportion to the signal amplitude, pulling the AGC line down from its nominal 1.2 V to as low as 0.6 V. The AGC line is connected to the input bias pins of both U1 and U2, so that the gain of both mixers is reduced as signal strength increases. R1 limits the gain reduction at U1, so most of the AGC action is due to U2, which minimizes the chance of front-end overload when AGC is activated. Only signals in the passband of the crystal filter can cause AGC in any case, so the AGC line stays at about 1.2 V most of the time.

Q10 and Q11 are shunt and series mute devices, respectively. Both are required due to the large amount of audio gain in the receiver.

U4 amplifies the received audio signal and sidetone to headphone or speaker level. The AF GAIN control is located on the front panel, but is electrically connected between Q11 and U4 at the AF1 and AF2 points.

In receive mode, the AGC signal is routed onto the RF/SMTR line, which is then sampled by an A-to-D input on the MCU (U1, front panel). Q1 is used to connect or disconnect the AGC signal from the RF/SMTR line.

Transmitter (Sheet 2)



To vary the power output, JFET Q5 and PIN diode D18 control the amount of premix signal input to the transmit mixer, U8. The DC control voltage at the drain of Q5 is set by the MCU (U1, front panel). ALC (automatic level control) is implemented in firmware. During keying, the ALC determines what DC voltage is needed to get to the requested power level, as well as what voltage corresponds to zero output. As you key the transmitter, the control voltage alternates between these two levels so that the keying waveform can be effectively shaped by R10 and C59.



Video amplifier U9 buffers and amplifies the TX mixer output. Q14 keeps U9 fully turned off during receive. The low-level transmit signal is passed through the RF band-pass filter on the Filter board via J7.

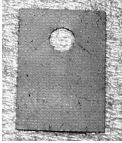

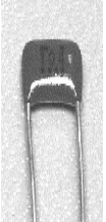
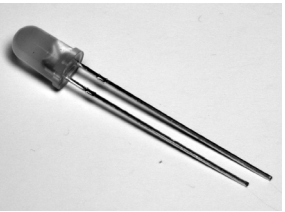
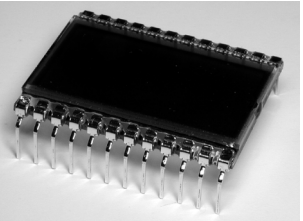

D9-D13 form a fast, high-isolation T-R switch that allows the appropriate RF band-pass filter to be shared between receive and transmit. On transmit the signal is routed through D9 to the driver transistor, Q6. On receive, D10, 11, and 12 are turned on, bypassing the transmit stages.

Q7 is the class-C final amplifier. It operates at a nominal collector impedance of 12.5 ohms, which is stepped up to 50 ohms by T4. Q7's output is filtered by one of the low-pass filters on the Filter board, with signals routed through J8. RF detector diode D15 samples some of the RF output voltage to provide a power output indication. If the KAT1 antenna tuner is installed, its SWR bridge/wattmeter output takes over from D15, via pin 5 of J8.







Appendix A K1 Packing Box Parts List Revised 11-30-2000				
PICTURE	Designators	Description	Part Number	QTY
	Misc.	RF PC board	E100094	1
	B1	Left side panel	E100097L	1
	B2	Right side panel	E100097R	1
	B3	Front panel, silkscreened	E100096SS	1
	B4	Bottom cover, silkscreened	E100098SS	1
	B5	Top cover	E100099	1
	Bag, Misc.	Hardware and miscellaneous components	E850024	1
	Bag, Wire	Wire and coax	E850023	1
	Bag, Filter Board	Components for 2 or 4-band Filter PC board	KFL1-2 or KFL1-4	1
	Bag, Per-Band Components	Additional Filter board components for two selected bands (2-band K1 kit only). Elecrafter order numbers shown at right.	K1B80, K1B40, K1B30, K1B20, K1B17, K1B15	2
	Bag, Front Panel Board	Components for Front panel PC board	E850021	1
	Bag, RF Board	Components for RF PC board	E850020	1
	HW (in envelope)	Thermal insulator, TO220; for Q6, Q7 (RF BOARD)	E700002	2

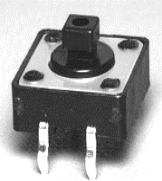

Appendix A K1 Packing Box Parts List Revised 11-30-2000				
PICTURE	Designators	Description	Part Number	QTY
	Misc (in envelope)	Acrylic display bezel; for LCD (Front Panel)	E100108	1
	Misc (in envelope)	Serial Number Label	E980024	1
	SP1	Speaker, 8-ohm, 1 watt	E980032	1
	KN1	Large knob, 1.25" dia, 0.25" shaft; Rogan #RB-67-3-M	E980021	1
	KN2, KN3	Small knob, 0.5" diam, 6mm shaft	E980016	2





Appendix A	K1 Front Panel Board Parts List			
PICTURE	Designators	Description	Part Number	QTY
	C1, C2	82 pF NPO disc; label: "82"	E530038	2
	C5, C6	.01 μ F, monolithic; label: "103"	E530009	2
	C4	.047 μ F, monolithic; label: "473"	E530025	1
	D1	LED, dual, orange/green; LiteOn LTL-298WJ (Digikey 160-1037)	E570000	1
	D2	LED, yellow; LiteOn LTL-4253 (Digikey 160-1133)	E570001	1
	D3	Diode (not used at present)		0
	DS1	3-character, 7-segment LCD (V.L. Electronics p/n VI-321-DP-RC-S-12)	E600015	1
	J1	20 pin x 1 female socket	E620025	1
	Q1	2N4124 transistor, TO-92 plastic	E580006	1
	Q2	2N7000 transistor, TO-92 plastic	E580002	1

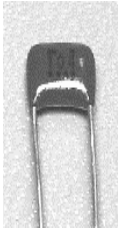

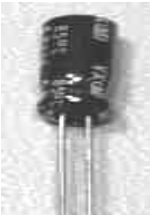

Appendix A	K1 Front Panel Board Parts List			
PICTURE	Designators	Description	Part Number	QTY
	R1	100 k, 10-turn potentiometer	E520007	1
	R2, R3	10 k potentiometer, linear taper	E520005	2
	R7	3.92 k, 1/4W, 1%; color code: org-wht-red-brown	E500031	1
	R6	12.7 k, 1/4W, 1%; color code: brn-red-violet-red	E500063	1
	R8	22 Ω, 1/4W, 5%; color code: red-red-black	E500028	1
	R13	470 Ω, 1/4W, 5%; color code: yellow-violet-brown	E500003	1
	R14, R15	1 k, 1/4W, 5%; color code: brown-black-red	E500013	2
	R12, R16	2.7 k, 1/4W, 5%; color code: red-violet-red	E500005	2
	R4, R5	10 k, 1/4W, 5%; color code: brown-black-orange	E500015	2
	R9, R10, R11, R19	100 k, 1/4W, 5%; color code: brown-black-yellow	E500006	4
	RFC1, RFC2	82 μH miniature RF choke, Mouser 434-22-820 (color code: gray-red-black)	E690003	2
	RP1	1 k SIP resistor pack, 8 pins, 4 resistors p/n 77083102 (alt: 8A3102G, L83C102, etc.)	E510006	1

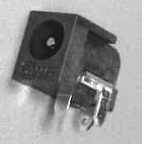

NOTE: Many of the resistors are supplied attached to strips of tape in assembly order, however some are also supplied loose
Be sure to check the color codes of all resistors during assembly to be sure you're installing the correct part.

Appendix A	K1 Front Panel Board Parts List			
PICTURE	Designators	Description	Part Number	QTY
	S1-S6	Switch, push button	E640005	6
	U1	PIC16C77MCU, programmed ("K1"), 40 pins	E610005	1
	U2	MAX518BCPA; Dual D/A converter, 8 pins Alt: MAX518ACPA	E600013	1
	U3	24LC04B/P; EEPROM, 8 pins (alternate: 24WC04P)	E600021	1
	U5	LM358, 8 pins	E600010	1
	U4	ZR78L06C; Voltage regulator, 6V, 2.5% (Zetex); TO-92 plastic, 3 pins	E600017	1
	X1	4.000 MHz crystal; HC-49, standard height	E660006	1
	Misc.	Front Panel PC board	E100093	1
	Misc	40 pin DIP socket (for U1)	E620017	1
	Misc	switch spacing tool (made from PCB material)	E980033	1
	Misc	nylon washer, 0.75" O.D., 0.385" I.D. (Keystone #3227)	E700019	1
	Misc	Keycap, rectangular, black	E980000	5
	Misc	Keycap, square, black	E980009	1



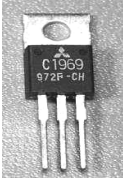

Appendix A	K1 RF Board Parts List			
PICTURE	Designators	Description	Part Number	QTY
	C14, C15, C16, C19, C22, C28, C29, C51	.001 μ F, monolithic; label: "102"	E530001	8
	C4, C6, C17, C18, C21, C23, C25, C36, C37, C40, C43, C44, C45, C47, C48, C49, C58, C60, C64, C66, C72, C74, C75, C76	.01 μ F, monolithic; label: "103"	E530009	24
	C24, C30, C32, C41, C50, C56, C57, C61	.047 μ F, monolithic; label: "473"	E530025	8
	C34, C46, C52, C55, C68, C70, C71, C73	0.1 μ F, monolithic; label: "104"	E530011	8
	C3	10 pF NPO mono or disc, 5%; label: "10"	E530006	1
	C65	22 pF NPO mono or disc, 5%; label: "22"	E530017	1
	C7, C26, C27	39 pF NPO mono or disc, 5%; label: "39"	E530036	3
	C2	68 pF NPO mono or disc, 5%; label: "68"	E530007	1
	C8	82 pF NPO mono or disc, 5%; label: "82"	E530038	1
	C1	150 pF NPO mono or disc, 5%; label: "151"	E530049	1
	C38, C39, C42, C69	220 pF NPO mono or disc, 5%; label: "221"	E530042	4
	C62, C63	330 pF NPO mono or disc, 5%; label: "331"	E530043	2
	C2A (alternate for C2)	120 pF polystyrene, axial leads, 5%; label: "120J"	E530070	1
	C11, C12	1200 pF polystyrene, axial leads, 5%; label: "1200J"	E530069	2
	C5	3300 pF polystyrene, axial leads, 5%; label: "3300J"	E530071	1
	C31, C54, C67	2.2 μ F electrolytic, 25V	E530023	3
	C78	Electrolytic capacitor, supplied with 80-m band kit (2-band module only)		0
	C33, C35, C59	10 μ F electrolytic, 35V; low-profile (Digikey P922-ND)	E530045	3
	C9, C10, C53	220 μ F electrolytic, 25V (Digikey P6240-ND)	E530046	3

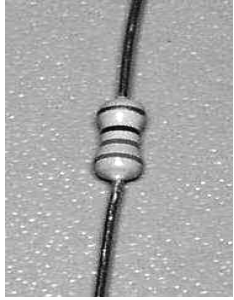
Appendix A	K1 RF Board Parts List			
PICTURE	Designators	Description	Part Number	QTY
	C13, C20	Ceramic trimmer capacitor, 8-50pF	E530000	2
	D2, D15	1N5711 Schottky diode, small glass pkg	E560004	2
	D5, D9-D14, D18	1N4007 PIN diode, large plastic pkg, black	E560001	8
	D19	1N4753 zener diode, 36 V, 1 watt	E560007	1
	D1, D17	1N4148 switching diode, small glass pkg	E560002	2
	D16	SB530 Schottky diode, 5A, very large plastic pkg (black) (alternate: 1N5821)	E560003	1
	D4	MV209	E560006	1
	D3, D6, D7, D8	1SV149; TO-92 pkg	E560005	4
	J6, J7, J8	8-pin 0.1" conn., female; Samtec SSW-108-01-G-S.	E620005	3
	J1	Supplied with noise blanker option (KNB1)	E620005	0
	J4	2.1 mm DC barrel connector	E620026	1
	J5	BNC jack	E620020	1

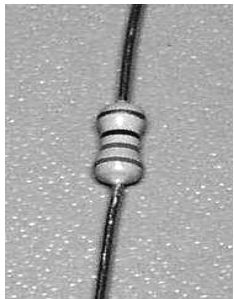
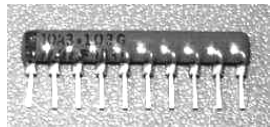
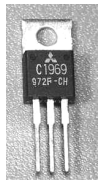
Appendix A	K1 RF Board Parts List			
PICTURE	Designators	Description	Part Number	QTY
	J3	Keyer Jack, threaded bushing, Stereo, vertical mount	E620027	1
	J2	Headphone jack, non-threaded, Stereo, with switch, horizontal mount	E620028	1
	J9, J10	2-pin, pads only (coax soldered to connections--see text)		0
	K1	Latching Relay, 5V; in plastic tube	E640001	1
	L1	T50-6; Toroid (yellow), approx. 4.4μH; 33 turns	E680010	1
	L2	FT37-43; Toroid (gray); 16 turns	E680003	1
	T1	FT37-43; Toroid (GRAY), 4:20, receiver mixer input	E680003	1
	T2	FT37-43; Toroid (GRAY), 5:20, product detector input	E680003	1
	T3	FT37-43; Toroid (GRAY), 12:4, driver to final	E680003	1
	T4	FT50-43; Toroid (GRAY, larger), 5 turns bifilar	E680008	1
	RFC8	Supplied with 80-m band kit (2-band module only)		0
	RFC9	15 μH RF choke; min. solenoidal; color code: brn-grn-black	E690012	1
	RFC2, RFC5	22 μH RF choke; solenoidal, color code: red-red-black	E690000	2
	RFC1	33 μH RF choke; solenoidal, color code: orange-orange-black (NOTE: orange bands may appear brown)	E690007	1
	RFC3, RFC4, RFC6, RFC7	100 μH RF choke; solenoidal, color code: brown-black-brown	E690004	4

Appendix A	K1 RF Board Parts List			
PICTURE	Designators	Description	Part Number	QTY
	P1	20 x 1 ,male, RA; 20 pin male, right angle. To Front Panel, J1	E620029	1
	P2	2 pin, male, 0.1" conn with locking ramp; for speaker	E620024	1
	P3	3 pin, male, 0.1" conn.; RF detector select	E620007	1
	Q6	2SC5739 or 2SC2166; driver	E5800	1
	Q7	2SC1969; PA (Power Amp)	E580008	1
	Q5, Q8, Q11	J309, JFET, TO-92	E580009	3
	Q9	2N3906, PNP, TO-92	E580000	1
	Q3, Q14	2N4124, NPN, TO-92	E580010	2
	Q1, Q10	2N7000, MOSFET, TO-92	E580002	2
	Q2	MPSA14, NPN Darlington, TO-92	E580011	1
	Q4	ZVN4424A, MOSFET, Hi-V; Thinner TO-92 Style	E580005	1
	R37	226 Ω, 1/4W, 1%; color code: red-red-blue-black	E500033	1
	R36	1.50 k, 1/4W, 1%; color code: brown-green-black-brown	E500034	1
	R3	8.25 k, 1/4W, 1%; color code: gray-red-green-brown	E500065	1
	R23	1.5 Ω, 1/4W, 5%; color code: brown-green-gold	E500044	1
	R30	3.3 Ω, 1/4W, 5%; color code: orange-orange-gold	E500064	1
	R15	10 Ω, 1/4W, 5%; color code: brown-black-black	E500054	1
	R22, R31, R32	33 Ω, 1/4W, 5%; color code: orange-orange-black	E500036	3
	R16, R18	75 Ω, 1/4W, 5%; color code: violet-green-black	E500037	2
	R11	82 Ω, 1/4W, 5%; color code: gray-red-black	E500038	1
	R17, R35	120 Ω, 1/4W, 5%; color code: brown-red-brown	E500022	2
R29, R38	270 Ω, 1/4W, 5%; color code: red-violet-brown	E500039	2	

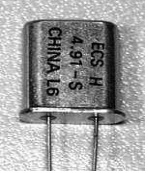
Appendix A	K1 RF Board Parts List			
PICTURE	Designators	Description	Part Number	QTY
	R10, R33	470 Ω, 1/4W, 5%; color code: yellow-violet-brown	E500003	2
	R7	680 Ω, 1/4W, 5%; color code: blue-gray-brown	E500040	1
	R12, R28	820 Ω, 1/4W, 5%; color code: gray-red-brown	E500001	2
	R1, R26, R27, R39	1.8 k, 1/4W, 5%; color code: brown-gray-red	E500004	4
	R5, R6, R9, R14, R21, R24	2.7 k, 1/4W, 5%; color code: red-violet-red	E500005	6
	R4	5.6 k, 1/4W, 5%; color code: green-blue-red	E500007	1
	R20	20 k, 1/4W, 5%; color code: red-black-orange	E500041	1
	R19	39 k, 1/4W, 5%; color code: orange-white-orange	E500042	1
	R2, R25, R34	100 k, 1/4W, 5%; color code: brown-black-yellow	E500006	3
	R13	2.2 M, 1/4W, 5%; color code: red-red-green	E500043	1
	RP1, RP2	100 k SIP resistor pack, 8 pins, 4 resistors p/n 8A3104G (alt: 77083104, L83C104, etc.)	E510018	2
	RP4, RP5	3.9 k SIP resistor pack, 6 pins, 3 resistors p/n 6A3392G (alt: 77063392, L63C392, etc.)	E510008	2
	RP6	27 k SIP resistor pack, 6 pins, 3 resistors p/n 6A3273G (alt: 77063273, L63C273, etc.)	E510009	1
	RP3	47 k SIP resistor pack, 10 pins, 5 resistors p/n 10A3473G (alt: 770103473, L103C473, etc.)	E510007	1
	U5	LM2930T-8, 8-volt regulator; TO-220 package	E600018	1

Appendix A	K1 RF Board Parts List			
PICTURE	Designators	Description	Part Number	QTY
	U4	LM380N-8, 8 pin DIP, AF amplifier	E600019	1
	U3	LM386N-1, 8 pin DIP, AF amplifier	E600022	1
	U9	LT1252, 8 pin DIP, VFO Buffer; TX Buffer	E600020	1
	U1, U2, U7, U8	SA602AN, 8 pin DIP, TX Mixer; Prod. Detector Alt: SA/NE612AN	E600006	4
	U6	ZR78L06C, 6-volt reg., 2.5%; TO-92 package, 3 pins	E600017	1
	W1	Jumper, RG174 coax, From J9 to J10; see text		0
	X1-X6	4.9152MHz Crystal; "ECS V4.9136" or similar. Filter/BFO Xtals; Parallel mode, matched, HC-49	E660000	6
	S1	DPDT Power Switch	E640006	1
	S2	Miniature DPDT slide switch	E640009	1
	MISC	2-pin shorting jumper for use at P3 (RF detector select)	E620055	1
	MISC	Keycap, rectangular, for S1 (p/n TAC-BLK)	E980023	1
	HW	#4, washer, nylon; Washer, nylon, 0.375" diameter (For VFO inductor)	E700035	2
	HW	#4-32, nut, nylon; nut, nylon (For VFO inductor)	E700021	1
	HW	4-32,screw, nylon x 1/2" screw, pan head, nylon (For VFO inductor)	E700022	1

Per-Band Components, 2-Band Filter Board only

(Refer to KFL1-4 manual for 4-band Filter board parts list)

Note: All Inductors in table below are wound with #26 red enamel wire on T37-6 cores (Elecrafit p/n E680013)

All capacitors are NPO disc or monolithic, 5% 0.2" lead spacing. Values are in pF.





*Some small-valued capacitors may use an "R" or other letter rather than a decimal point, e.g. "2R7".





Ref. Designators		Qty.	Components					
Band1__	Band2__		80 meters* (3.5 MHz)	40 meters (7.0 MHz)	30 meters (10.0 MHz)	20 meters (14.0 MHz)	17 meters (18.0 MHz)	15 meters (21.0 MHz)
C1, C5	C6, C10	2	470 ("471")	390 ("391")	220 ("221")	180 ("181")	100 ("101")	100 ("101")
C2, C4	C7, C9	2	1200 ("122")	330 ("331")	180 ("181")	120 ("121")	82	68
C3	C8	1	10	4.7 or 5*	2 or 2.2*	1	1	1
C11, C15	C16, C20	2	5600 ("562")	2200 ("222")	1800 ("182")	1000 ("102")	680 ("681")	470 ("471")
C12, C14	C17, C19	2	2700 ("272")	560 ("561")	270 ("271")	120 ("121")	82	56
C13	C18	1	82	10	4.7 or 5*	2.7, 3, or 3.3*	2 or 2.2*	2 or 2.2*
C21, C23	C24, C26	2	1200 ("122")	470 ("471")	330 ("331")	220 ("221")	180 ("181")	150 ("151")
C22	C25	1	2200 ("222")	820 ("821")	560 ("561")	390 ("391")	330 ("331")	270 ("271")
L9, L10	L11, L12	2	2.5 μ H 28 turns 20" (51 cm)	1.40 μ H 21 turns 14" (36 cm)	1.0 μ H 18 turns 12" (30 cm)	0.8 μ H 15 turns 11" (28 cm)	0.6 μ H 13 turns 10" (25 cm)	0.5 μ H 12 turns 9" (22 cm)
X1	X2	1	11.500 MHz p/n E660011	15.000 MHz p/n E660008	18.000 MHz p/n E660007 or 18.100 MHz p/n E660010	22.000 MHz p/n E660004	26.050 MHz p/n E660012	29.000 MHz p/n E660005

* NOTE: The 80-meter band kit also includes 10 μ F electrolytic capacitor C78 that is installed on the RF board.

Capacitor Part Numbers

Value	p/n	Value	p/n	Value	p/n
1	E530068	150	E530049	1200	E530005
2 or 2.2*	E530047	180	E530008	1500	E530002
2.7, 3, or 3.3*	E530065	220	E530042	1800	E530035
4.7 or 5*	E530048	270	E530050	2200	E530054
10	E530006	330	E530043	2700	E530003
22	E530017	390	E530051	5600	E530073
56	E530015	470	E530004		
68	E530007	560	E530052		
82	E530038	680	E530053		
100	E530034	820	E530018		
120	E530041	1000	E530072		

Appendix A		K1 Misc. Bag Parts List		
PICTURE	Designators	Description	Part Number	QTY
	HW	#4 int. tooth lockwasher (3 Spares)	E700010	10
	HW	#4 split lockwasher (4 Spares)	E700004	16
	HW	2-56,screw , 1/8", stainless steel, fillister head (2 spares)	E700023	6
	HW	2-D Fastener	E100078	8
	HW	4-40 nut, Steel-zinc (2 spares)	E700011	9
	HW	4-40 screw, 1/4" Panhead phillips, steel-zinc	E700005	1
	HW	4-40 screw, 3/8" Panhead phillips, steel-zinc	E700036	1
	HW	4-40 screw, 3/16" Panhead phillips, black (5 spares)	E700015	25
	HW	4-40 screw, 5/16" Flathead phillips (undercut), BLK (2 spares)	E700027	7
	HW	4-40 screw, 3/16" Flathead phillips (undercut), BLK (3 spares)	E700025	16
	HW	4-40 standoff, round, 1/4" long x 3/16 dia. (for FP board)	E700026	1
	HW	4-40 male/female standoff, hex, 7/16" long x 3/16" dia.; RAF 4504-440-A (for Filter board)	E700017	3
	HW	Shoulder washer, nylon, black (for PA transistor, Q7)	E700001	1
	HW	Self-adhesive rubber foot (Digikey SJ5518-0-ND)	E700024	4
	Misc	LCD spacer, 0.5 x 0.5 x 0.187", self-adhesive both sides	E700020	1
	HW	#4 flat washer, steel-zinc (for speaker); one spare	E700044	5
	HW	#4 washer, .047" thick, fiber, black (for speaker)	E700028	4

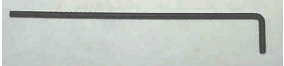
Appendix A		K1 Misc. Bag Parts List		
PICTURE	Designators	Description	Part Number	QTY
	SPK-J1	2 pin female conn. Housing, 0.1" spacing, locking ramp. (for speaker)	E620021	1
	ACC-P1	2.1mm male conn. (mates with DC power jack)	E620032	1
	ACC-P2	Stereo 1/8" phone plug (for key, keyer, paddle, computer, or other keying device)	E620033	1
	Misc	Female crimp pins for SPK-J1	E620022	2
	Misc	Plastic tuning tool, p/n MARS-12	E980012	1
	Misc	Allen wrench, 5/64", long handled (for large knob)	E980004	1
	Misc	Allen wrench, .05", short handled (for small knobs)	E980008	1

Appendix A		K1 Wire Bag Parts List		
PICTURE	Designators	Description	Part Number	QTY (ft)
	Misc	#26 Red Enamel Wire (for toroids)	E760002	14
	Misc	#26 Green Enamel Wire (for toroids)	E760004	4
	Misc	#22 Dual-conductor wire (for speaker)	E760012	1
	Misc	#24 solid-conductor hookup wire, insulated, green	E760008	1
	Misc	Coax, RG174 (for jumper from J9 to J10, RF board)	E760010	0.5

Transistors

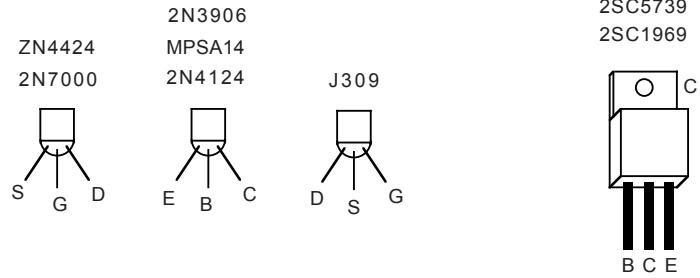

Diodes

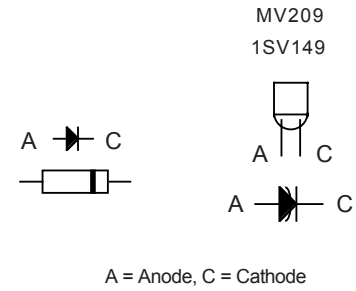

Integrated Circuits

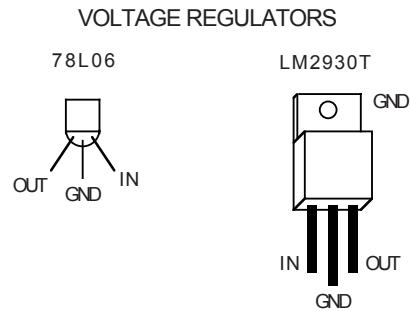
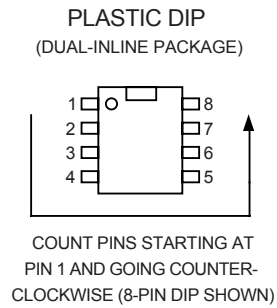

LEDs

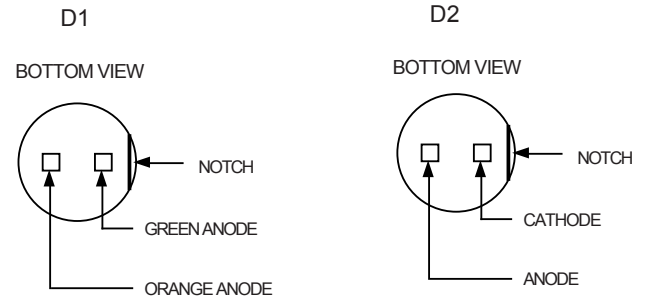

Special Symbols

 = On bottom of PC board.

Elecraft K1 Schematic Key			
By W. Burdick E. Swartz	Rev. A	Date 9/4/00	Sht. 1 of 1

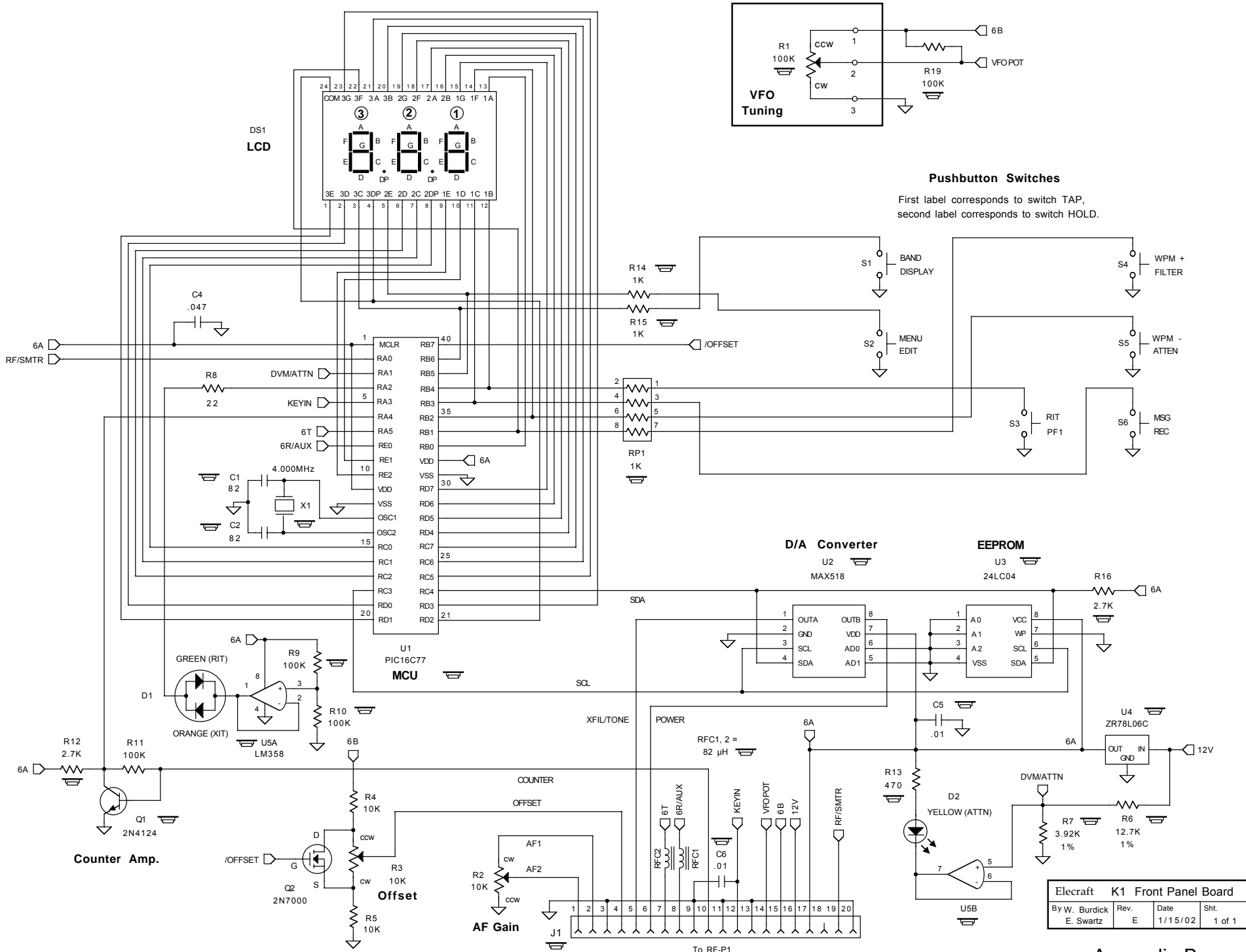

Elecraft K1 Front Panel Board			
By W. Burdick	Rev. E	Date 1/15/02	Sht. 1 of 1
E. Swartz			

Appendix B

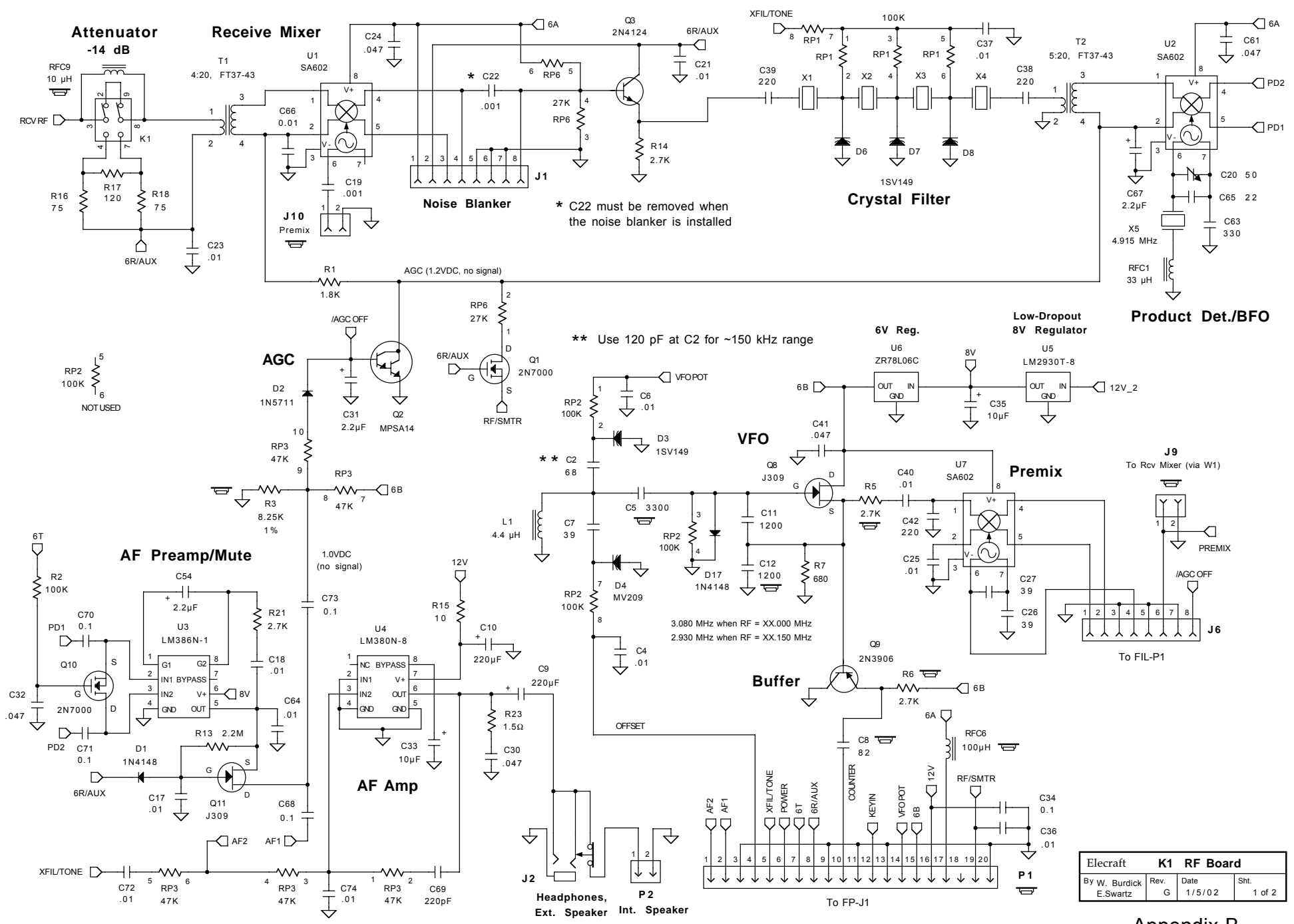

ElecRAFT K1 RF Board			
By W. Burdick E. Swartz	Rev. G	Date 1/5/02	Sht. 1 of 2

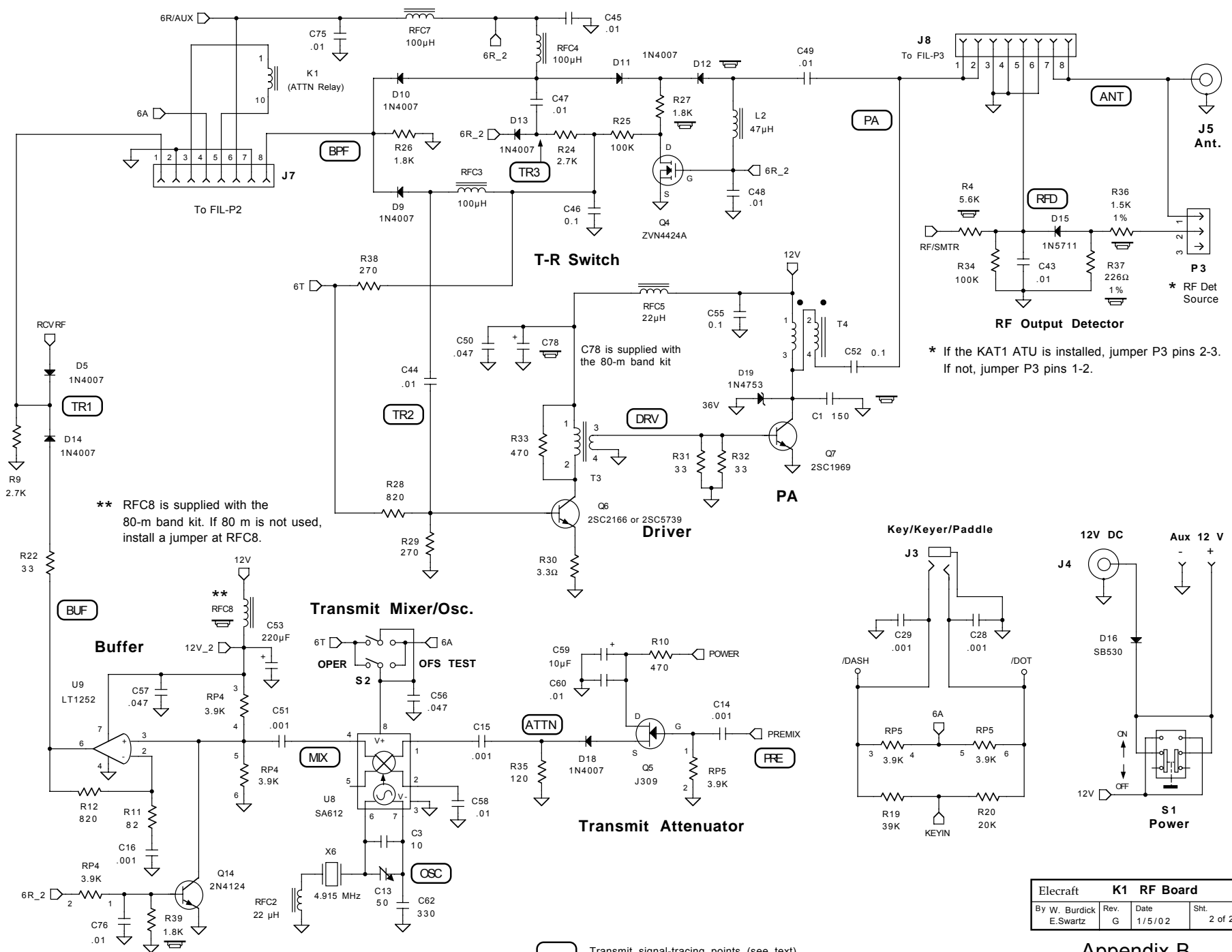

** RFC8 is supplied with the 80-m band kit. If 80 m is not used, install a jumper at RFC8.

* If the KAT1 ATU is installed, jumper P3 pins 2-3. If not, jumper P3 pins 1-2.

○ Transmit signal-tracing points (see text)

Elecraft K1 RF Board			
By W. Burdick E.Swartz	Rev. G	Date 1/5/02	Shit. 2 of 2

Appendix B

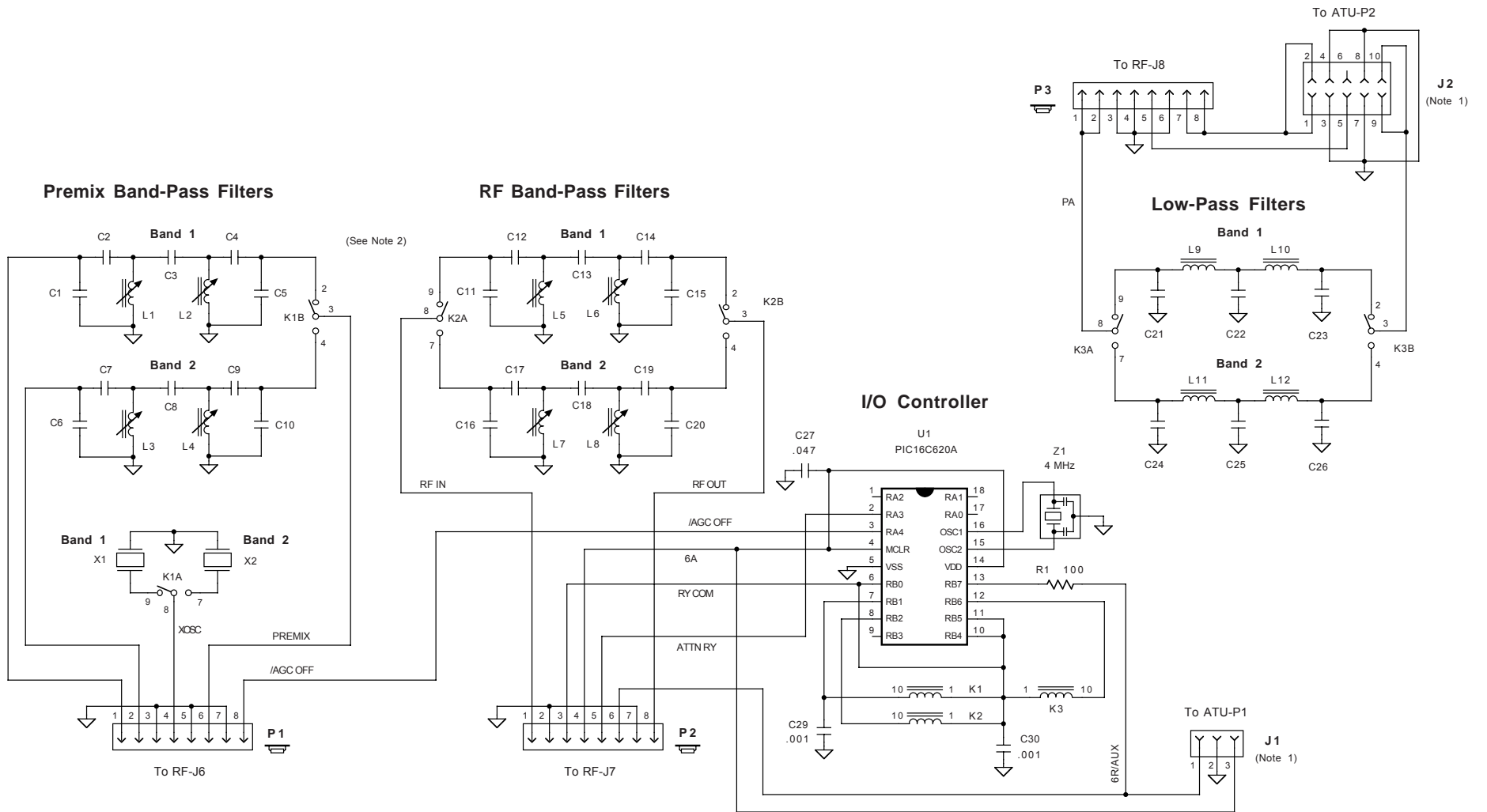

Notes:

1. J1 and J2 are supplied with the KAT1 option (Antenna Tuner). If the KAT1 is not installed, J2 pins 2 and 10 must be connected using a jumper (see text).
2. See Parts List for values of all band-specific components.
3. K1-K3 are latching relays, and are shown in the RESET position. Pins 5 and 6 of relays are not connected internally, but may be used as tie points for other circuitry on the PC board.
4. This schematic is for the 2-band Filter board. Refer to KFL1-4 manual for 4-band Filter board schematic.

ElecRAFT K1 2-Band Filter Board			
By W. Burdick E.Swartz	Rev. E	Date 1/5/02	Sht. 1 of 1

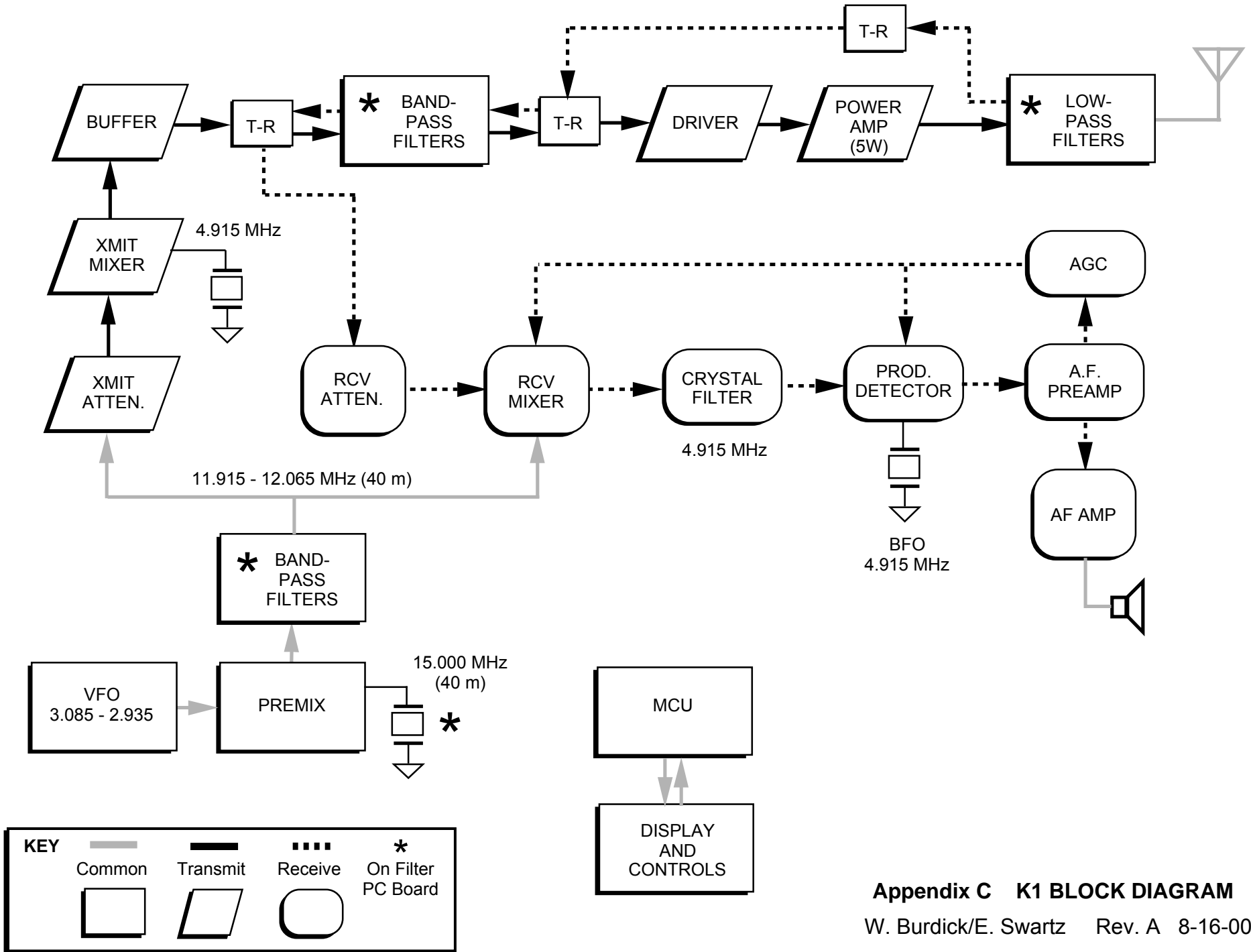

Appendix D. K1 Assembly Photographs

Completed K1 with top cover and side panels removed; Front Panel and 2-band Filter board shown Plugged into the RF board.

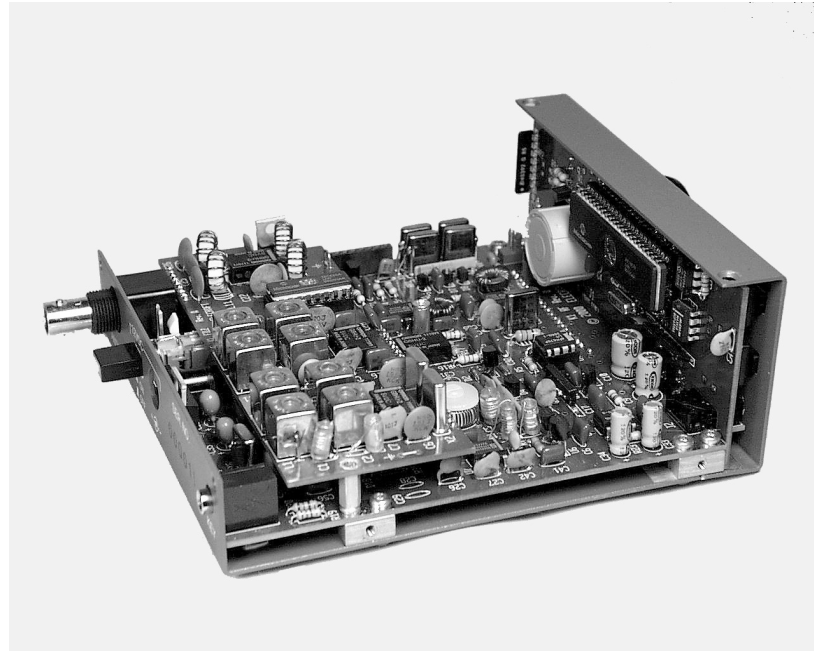

RF board with bottom cover Attached (headphone jack is visible at left)

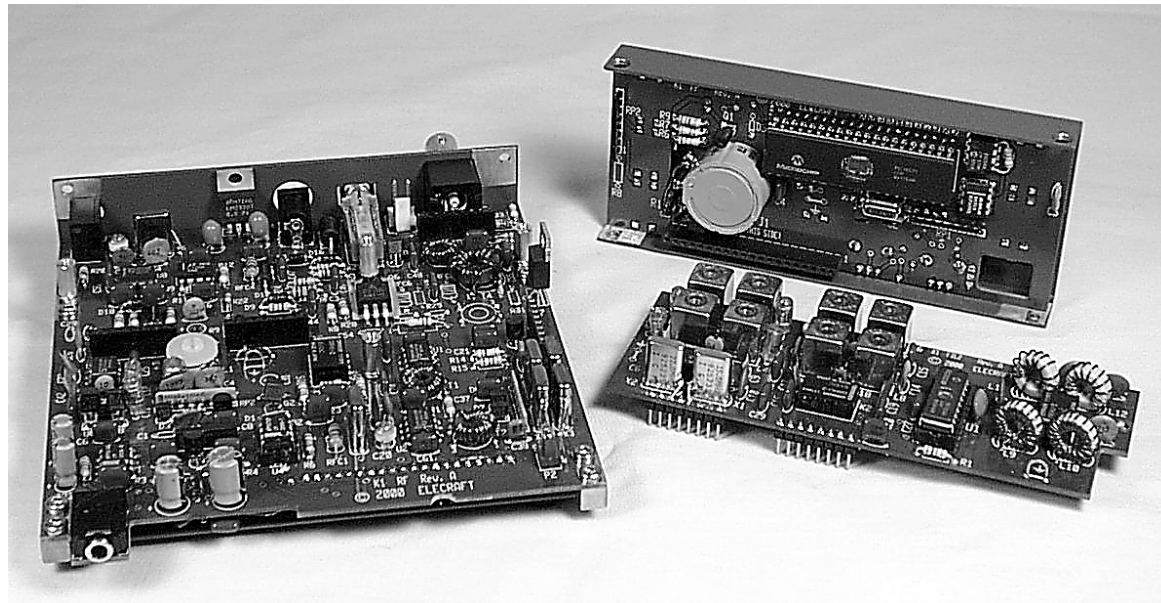

Front Panel assembly

2-Band Filter Board

Appendix E, Troubleshooting

General Troubleshooting Procedure

- Look for your problem in the **Troubleshooting Tables**.
- Closely examine PC boards for poor solder joints and incorrect, broken or missing components.
- Follow the step-by-step receiver and transmitter **Signal Tracing** procedures at the end of this section.
- Check voltages using the **DC Voltage Table** at the end of this section.

Error Messages

If you see a message such as **E30** on the LCD, look up the corresponding entry in the Troubleshooting Tables. Error messages can usually be cleared by pressing any switch. However, the cause of the message should be investigated before continuing to operate the transceiver.

Troubleshooting Tables

There are five troubleshooting tables (listed below). Within each table, problems are identified by 2-digit numbers for cross-referencing purposes. In most cases you'll know which table to look in based on the symptoms you observe. If in doubt, start with the General Troubleshooting table. Some problem identifiers have corresponding **error messages** (see above).

General Troubleshooting	00-19
Display and Control Circuits	20-39
VFO and Premixer	40-59
Receiver	60-79
Transmitter and Keyer	80-99

Note: Components are identified by their PC board and reference designator. For example, "FP-U1" means U1 on the Front Panel board.

General Troubleshooting (00-19)

Problem	Troubleshooting Steps
00 Unit appears to be completely dead when power switch is turned on (no display, no audio); possible smoke, hot components, etc.	<ul style="list-style-type: none"> ▪ Make sure your power supply is connected, turned on, and not plugged in backwards ▪ Check fuses; examine cables for open/short ▪ Check resistance to ground on 12V, 8V, and 6V lines; check for RF-Q7 tab short ▪ Verify front panel and filter boards are plugged in, with connectors fully seated ▪ Measure the +6V and +8V regulated power supplies (20) ▪ Check the MCU, FP-U1 (26)
01 LCD or LED problem	<ul style="list-style-type: none"> ▪ See control circuits (24)
02 BAT LO displayed	<ul style="list-style-type: none"> ▪ Battery voltage may be below 9 V. Recharge the battery as soon as possible.
03 No audio	<ul style="list-style-type: none"> ▪ See Receiver troubleshooting table (60)
04 Switches or potentiometers do not function correctly or are intermittent	<ul style="list-style-type: none"> ▪ Front panel board may not be plugged in ▪ Check the MCU (26) ▪ Check all regulated supply voltages (20) ▪ Check switches and related components (21)
05 Current drain is excessive on receive	<ul style="list-style-type: none"> ▪ Check regulated voltages (20); look for a component that's warm to the touch
06 Supply voltage drops when K1 is on	<ul style="list-style-type: none"> ▪ Check receive-mode current drain (05) ▪ Battery not fully charged
07 Error in actual vs. displayed frequency	<ul style="list-style-type: none"> ▪ See Operation section (VFO Calibration)
08 Freq. drift or instability	<ul style="list-style-type: none"> ▪ See VFO troubleshooting table (40)
09 EEPROM init is pending	<ul style="list-style-type: none"> ▪ See Advanced Operating Features, <i>Resetting to Factory Defaults</i> (page 57)
10 EEPROM was just initialized	<ul style="list-style-type: none"> ▪ You may see E10 one time on power-up, or if you install a new version of the firmware. All K1 parameters are set to defaults.
15 END or P=0 is displayed on keydown	<ul style="list-style-type: none"> ▪ END: TX out of range (see specifications) ▪ P=0: TX disabled via OUT menu entry

Display and Control Circuits (20-39)

Problem	Troubleshooting Steps
20 Regulated voltage(s) incorrect	<ul style="list-style-type: none"> DC input voltage must be > 8.5V Remove all option boards and re-check If +6V is too low (< 5.7V) go to 22 If +8V is too low (< 7.5V) go to 23
21 General problem with switches or potentiometers	<ul style="list-style-type: none"> Check switch resistance open/closed; check R14, R15 and RP1 Check resistance of potentiometers; check related connections to FP-J1
22 +6A or +6B voltages too low (< 5.7V)	<ul style="list-style-type: none"> Remove socketed ICs, front panel board, filter board, and options individually Inspect the entire 6A or 6B path on the RF and Front Panel boards. Check for regulator ICs installed backwards Lift the output lead of the affected regulator and measure the voltage this lead; if the voltage is still too low, replace the IC Lift other component leads on the 6V line as needed to find cause of excess loading
23 +8V too low (< 7.5V)	<ul style="list-style-type: none"> Use techniques given for 6V regulators (above)
24 LCD or LED problem	<ul style="list-style-type: none"> LCD in backwards or bent pin; check for shorts to ground on each LCD pin MCU pin bent or broken (FP-U1) LEDs swapped or installed backwards
25 Relay Problem	<ul style="list-style-type: none"> Relays installed backwards or not soldered Check relay coil resistance, pins 1 and 10 I/O controller defective or backwards (27)
26 Possible MCU problem	<ul style="list-style-type: none"> Check all DC voltages on FP-U1 Remove the Front Panel board and inspect U1. Make sure it is not backwards, has no bent pins, and is seated firmly in its socket. Check oscillator components (X1, C1, C2). Also see (33) if you suspect an error in a menu parameter, etc.

27 Filter board not plugged in, or I/O controller (FIL-U1) communication problem	<ul style="list-style-type: none"> If you saw the message E27, the I/O controller (IOC, FIL-U1) did not respond to messages from the main processor (MCU, FP-U1). Turn power OFF and back ON; if you hear some relays switching, the IOC may be OK, and the problem is likely to be with the AuxBus (29) If you do not hear any relays switching on power-up, your IOC (FIL-U1) may be defective. Inspect FIL-U1 to see if you have installed it backwards or if any pins are bent. With power ON, check all voltages associated with U1. You should see 6V at pins 1 and 14. See DC voltage table.
28 I/O controller data error	<ul style="list-style-type: none"> If you saw the message E28, the I/O controller (IOC, FIL-U1) sent an incorrect response to the MCU (FP-U1). This may indicate a firmware incompatibility.
29 AuxBus problem	<ul style="list-style-type: none"> Try removing each option board If voltage at pin 13 of the IOC (FIL-U1), the auxBus line may be shorted Try tapping the BAND switch quickly while watching pin 13. It should drop below 6V briefly if the MCU (FP-U1) is sending a message to the IOC. Check the AuxBus signal at the MCU, pin 8 (FP-U1). The voltage should drop below 6V briefly when the band is changed.
30 EEPROM write/read test #1 failed 31 EEPROM write/read test #2 failed 32 EEPROM data error	<ul style="list-style-type: none"> If you E30, E31 or E32 on the LCD, one of the EEPROM tests has failed. CW memories cannot be used. Parameters will be set to defaults, and band 1 will be selected. Verify that the Filter board is plugged in. Check all voltages on the EEPROM (FP-U3) Inspect FP-U3 and surrounding traces Make sure FP-R16 is installed
33 Configuration data or menu problem	<ul style="list-style-type: none"> If a menu parameter is out of range or can't be modified, EEPROM may need to be reinitialized. See page 57 for instructions.

VFO and Premixer (40-59)

Problem	Troubleshooting Steps
40 General VFO problem; frequency jumps or drifts	<ul style="list-style-type: none"> ▪ Note: Some VFO drift will always be present due to aging of components and heating or cooling of the cabinet ▪ The VFO will drift more if you used the larger range (C2=120 pF). ▪ Use CAL menu entry to check actual VFO frequency (hold EDIT to show the operating frequency calibration display, then switch to OSC using DISPLAY) ▪ Make sure supply voltage is above 8.5V ▪ If you used solder with water-soluble flux, clean the board with hot water and a Q-tip ▪ Make sure L1 leads are properly stripped ▪ Check crystals on Filter board
41 Can't tune VFO (or RIT/XIT offset)	<ul style="list-style-type: none"> ▪ Check actual VFO range (40) ▪ Measure voltage on anode of RF-D3 (VFO main varactor diode) while tuning VFO pot ▪ Measure voltage on anode of RF-D4 (offset varactor diode) while tuning the OFFSET pot ▪ Varactors may be installed backwards
42 VFO inductor not installed or VFO not oscillating	<ul style="list-style-type: none"> ▪ If you see E42, the VFO signal is either missing or is too low in amplitude to be counted by the MCU (FP-U1). ▪ Check all VFO components ▪ Check the counter amplifier and related components (FP-Q1, R11, R12) ▪ Use signal tracing to determine where the VFO signal is getting lost
45 VFO tunes the wrong way	<ul style="list-style-type: none"> ▪ VFO pot (FP-R1) CCW and CW leads may be reversed
46 VFO or RIT/XIT range is too large, too small, or shifted low/high	<ul style="list-style-type: none"> ▪ Check actual VFO range (40) ▪ Varactor diodes may be wrong type ▪ Check all capacitors in VFO, esp. C2 and C7 ▪ See Alignment and Test, Part I.

Receiver (60-79)

Problem	Troubleshooting Steps
60 Low (or no) audio output from receiver, or general receiver gain problem	<ul style="list-style-type: none"> ▪ If you hear normal audio output on one band but not all bands, see 62 ▪ Make sure you have headphones or speaker connected; turn AF GAIN clockwise ▪ Check the key jack for a short to ground ▪ Make sure the attenuator is turned off ▪ Re-peak the band-pass filters ▪ Check for ground shorts in the LPF and BPF ▪ Turn the AF GAIN to maximum. If you don't hear any "hiss" at the receiver output, troubleshoot the AF amplifier (65) ▪ Check the 8V regulated supply voltage and troubleshoot if necessary (20) ▪ Try using signal tracing (see procedure later in this section)
62 Signal loss only on one band	<ul style="list-style-type: none"> ▪ Re-do alignment on affected band ▪ Check the band-pass and low-pass filters and crystal for this band ▪ Check functioning of the associated relays (change bands, then measure relay leads that should be open or shorted for that band)
65 AF amplifier not working	<ul style="list-style-type: none"> ▪ Use the STL menu entry to set a sidetone level of 31. If you hear a strong tone, the A.F. amplifier (RF-U4) is probably working, and the problem is likely to be with the preamp (RF-U3) or other RF board circuits. ▪ Signal trace through the receive chain backwards by touching a tool or wire to various points along the receive path ▪ Check all DC voltages in the receiver ▪ Inspect the A.F. amp and preamp circuits
70 AGC or S-meter not working	<ul style="list-style-type: none"> ▪ Make sure the attenuator is off ▪ Check voltages on RF-U1, U2, Q1, Q2, D2

Transmitter and Keyer (80-99)

Problem	Troubleshooting Steps
80 General Transmitter problem	<ul style="list-style-type: none"> ▪ If power output is too low, go to 86 ▪ If power output slowly increases during key-down, go to 88 ▪ If current drain on transmit is too high for the given power level, go to 92 ▪ If the transmitter output power seems to be unstable go to 88 ▪ If the transmitter stops transmitting by itself go to 90 ▪ If the keyer isn't working properly, go to 95 ▪ Try signal tracing
86 Power output is low or zero	<ul style="list-style-type: none"> ▪ Check power output when using a 50Ω dummy load; if the output is correct on a dummy load but not when using an antenna, your antenna is probably not matched ▪ Check all component values in the RF detector; you may have two resistors swapped (R36, R37) or the wrong detector diode (D15, should be 1N5711) ▪ You may have a short in the LPF or BPF; also check relays (25) ▪ Examine T3 and T4; these must be wound as indicated in part II of the RF board assembly ▪ Look for toroid leads that are not completely stripped or are soldered poorly ▪ Check all DC voltages in the transmitter (RF board, Q5/Q6/Q7, U8, U9) ▪ If drive is lacking, R35 (RF board, TX attenuator) can be made larger, at the expense of power-setting resolution. ▪ Make an RF probe and signal-trace through the transmitter to find where signal is lost (see probe and procedure later in this section) ▪ Check for any components getting hot ▪ Check for RF-Q7's tab shorted to the right side panel (ground)

88 Power output fluctuates	<ul style="list-style-type: none"> ▪ If you stay in key-down (TUNE) mode for several seconds, it is normal to see some increase in power; this is due heating of the final amplifier transistor. ▪ If power goes up and down significantly during normal keying, you may have a poorly-matched antenna OR you may have power set too high for your battery or power supply to handle; try reducing power ▪ Make sure none of the diodes in the T-R switch circuits are in backwards ▪ If the transmitter is unstable (oscillating) even when connected to a 50-Ω load, you may have an incorrect component value or a toroid-winding error (86)
90 Output power drops to zero suddenly	<ul style="list-style-type: none"> ▪ If you have transmit power set too high for your battery or power supply, the supply voltage may drop so low on transmit that it resets the MCU (FP-U1) or the I/O controller (FIL-U1). Reduce power.
92 Current drain too high on transmit	<ul style="list-style-type: none"> ▪ You may have power set higher than the final amplifier can achieve for a given load or power supply voltage, resulting in overdrive of transmitter stages. Reduce power to see if normal current drain is restored. ▪ Damaged PA transistors or other components could cause inefficiency in any stage of the transmitter. Check all DC voltages and components; signal trace if necessarily (86)
95 Keyer Problem	<ul style="list-style-type: none"> ▪ If the keyer is generally erratic when transmitting and seems to get worse as power is increased, you probably have RF leaking into the keyline. Try bypassing your key with .001 μF capacitors; also try 100 μH RF chokes in series with the paddle connections. ▪ Seek a better antenna match ▪ Improve your ground system (if you have RF problems, add two or more radials cut to 1/4-wavelength at the affected frequency)

Signal Tracing

You can solve nearly all problems yourself by signal tracing using an RF probe and signal source, such as the ones shown here.

RF Probe

The RF probe shown in Figure 1 converts RF signals to DC so they can be measured using a DMM.

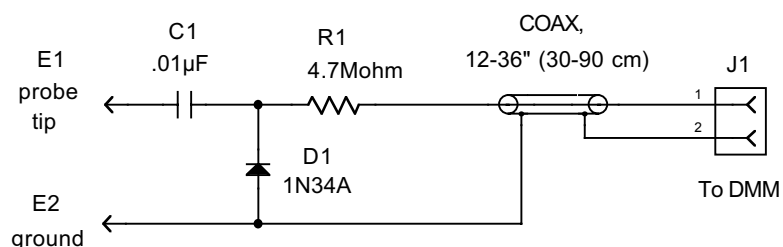

Figure 1

The probe tip (E1) should be no longer than 3" (see any *ARRL Handbook* for ideas), and you should not touch the tip while taking measurements. Use an alligator clip at E2, with a 4" (13 cm) lead.

Note: With this RF probe, DC voltage readings on your DMM will be *approximately* equal to the signal voltage in V_{rms} (root-mean-square). However, the error in the reading is quite significant for small signals (typ. -50% at 50 mVrms). The signal tracing procedures take this error into account.

Crystal Oscillator

The simple crystal oscillator shown in Figure 2 can be used in lieu of a commercial signal generator. It will run on voltages as low as 8 V, but 12 V or higher is recommended.

The components are not critical, and can vary 20% with little variation in performance. Nearly any NPN RF transistor will work in the circuit. Crystal X1 should be chosen for the band in use. The potentiometer can be any small trimmer or panel mount unit, but should not wire-wound.

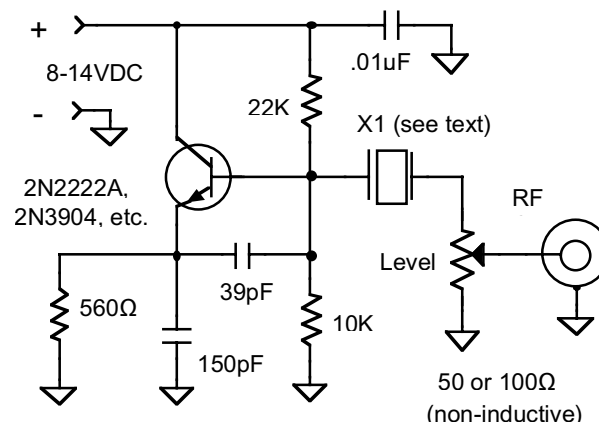

Figure 2

Receiver and VFO Signal Tracing

In the following steps you'll use an RF probe, DMM, and a signal source to find the stage where the received signal is getting lost or attenuated. You can then use voltage tables and resistance checks to find the bad component or connection. Space is provided at each step to record your measurements, which can vary as much as 25% in most cases and still be acceptable. Test points and components are on the RF board unless otherwise indicated.

1. Connect the RF probe's output to your DMM's +/- DC input jacks. Select a 2 or 3-V DC range.
2. The DMM should read close to 0.000 V DC, and the reading should increase when you touch the RF probe tip with your finger.
3. Turn on the K1 and switch to the desired band. Use the menu to turn AGC OFF. Set AF GAIN to minimum.
4. Connect the RF probe's ground clip to the ground jumper near the VFO inductor, L1. The probe tip will be touched to the points indicated in the following steps.
5. **VFO:** U7, pin 1 (U7 is near the left edge of the RF board). Expected DMM indication: .02-.04 V (DC). Actual: _____.
6. **Premix crystal:** U7, pin 7. Expected: .04-.25 V. Actual: _____.

7. **Premixer:** U7, pin 4 or 5 (whichever is greater). Expected: .04-.25 V. Actual: _____.
8. **Premix band-pass filter:** FIL-P1, pin 6. (FIL-P1 is an 8-pin connector on the Filter board, near the crystals. Pin 6 is the third pin from the right end.) Expected: .04-.15 V. Actual: _____. (Note: the expected voltage takes into account the de-tuning effect of the RF probe. The signal level would be higher if the filter was re-tuned to compensate for it.)
9. **BFO:** U2, pin 7. Expected: .015-.100 V. Actual: _____.
10. Connect a signal generator or test oscillator to the antenna jack. Set the signal level to about 0.14 V_{rms} as indicated by the RF probe, with the probe tip on pin 8 of FIL-P3 (right-hand end of the 8-pin connector on the Filter board near the antenna jack).
11. **Low-pass filter:** FIL-P3, pin 1. Expected: .12-.16 V. Actual: _____.
12. **T-R switch:** FIL-P2, pin 8 (P2 is the front-center 8-pin connector on the Filter board). Expected: .07-.12 V. Actual: _____.
13. **RF band-pass filter:** FIL-P2, pin 1. Expected: .06-.13 V. Actual: _____.
14. **Attenuator and T1:** U1, pin 1. Expected: .40-.70 V. Actual: _____.
15. **Receive mixer:** U1, pin 4. Expected: .50-.80 V. Actual: _____.
16. **Post-mixer amp:** R14, right end. Expected: .50-.80 V. Actual: _____.
17. Connect a pair of headphones or a speaker and adjust the AF GAIN so that you can just hear some background noise. Tune the VFO until you can hear the signal from your test generator peaked in the crystal filter. Since AGC is turned off, the signal may be extremely loud and will probably be clipping (distorted) at the AF output.
18. **Crystal filter:** U2, pin 1. Expected: .30-.50 V. Actual: _____. (Re-peak the signal using the VFO as needed.)
19. Disconnect the RF probe from the DMM.
20. Set up the DMM to read AC volts, 20 or 30-V meter range. Connect the (-) lead of the DMM to one of the ground test points using an alligator clip. The (+) lead will be touched to the points indicated in the following steps.
21. **Product detector (saturated output):** U2, pin 4. Expected: .40-.80 V (AC rms). Actual: _____. (Re-peak the signal using the VFO as needed.)
22. **AF preamp:** U3, pin 5. Expected: 2-4 V. Actual: _____.
23. **AF amp:** U4, pin 6. Output voltage should vary from 0 to about 4 or 5 V as the AF GAIN control is varied.

Transmitter Signal Tracing

In the following steps an RF probe is used to determine where the transmitted signal is getting lost or attenuated. *These checks are made from the bottom side of the RF board so that the Filter board can be left plugged in.* Each transmit test point is clearly labeled, with a small arrow pointing to the appropriate PC board pad. You'll want to refer to the transmitter schematic (K1 RF Board, sheet 2) as you perform the measurements.

1. Do the VFO and receiver signal tracing first to check VFO/premix signals.
2. Connect a dummy load to the antenna jack.
3. Turn the K1 upside-down and remove the bottom cover.
4. Install a very short jumper from the point labeled **DRV** to ground. This allows measurement of all low-level transmit stages.
5. Turn on the K1 and switch to the desired band. Set the power level to 3 watts using the OUT menu entry.
6. Connect the RF probe's ground clip to the ground jumper on the bottom of the RF board, near the center. Connect the RF probe's output to the DMM, and set the DMM for DC volts (2 or 3 V scale).

In the remaining steps, touch the RF probe tip to the indicated points and enter TUNE mode to take a reading. (Hold WPM+/WPM- together to activate TUNE.) Cancel TUNE after each reading by tapping any other switch.
Note: Do not key the transmitter for more than about 10 seconds at a time.

7. **PRE (premix):** Expected: .04-.09 V (DC). Actual: _____.
8. **ATTN (TX attenuator):** Expected: .02-.05 V. Actual: _____.
9. **OSC (TX 4.915 MHz):** Expected: .01-.04 V. Actual: _____.
10. **MIX (TX mixer):** Expected: 0.1-0.2 V. Actual: _____.
11. **BUF (TX buffer):** Expected: 1.5-2.0 V. Actual: _____.
12. **TR1 (first TX T-R):** Expected: 0.5-1.0 V. Actual: _____.
13. **BPF (band-pass filter):** Expected: 0.5-1.0 V. Actual: _____.
14. **TR2 (second TX T-R):** Expected: 0.5-1.0 V. Actual: _____.
15. **TR3 (receive signal shunt):** Expected: < .01 V. Actual: _____.
16. Remove the short from **DRV** to ground. Set DMM scale to 20 or 30 V.
17. **DRV (driver):** Expected: 0.9-1.6 V. Actual: _____.
18. **PA (power amp):** Expected: 10-15 V. Actual: _____.
19. **ANT (low-pass filter):** Expected: 10-12 V. Actual: _____.
20. Disconnect the RF probe. (The last measurement is DC volts, not RF.)
21. **RFD (RF output detector):** Expected: 1.7-2.0 V. Actual: _____.

DC Voltage Table

NOTES: Measurements listed for FIL-U1 apply only to the two-band Filter board; for 4-band Filter board voltages, refer to the KFL1-4 manual. Measurements were made with a 50-ohm dummy load connected and a supply voltage of 14 V. In general, your measurements should be within 10% of the values shown. **Pins NOT listed in the table should indicate 0.0 volts DC. Pins marked with (*) are hard to measure due to noise pickup. Shaded areas show transmit-mode measurements (using TUNE), made with the Filter board removed.**

Reference designators are prefixed with the board identifier: “FP” = front panel board, “RF” = RF board, “FIL” = filter board.

Ref.	Pin	VDC	Ref.	Pin	VDC	Ref.	Pin	VDC	Ref.	Pin	VDC	Ref.	Pin	VDC	Ref.	Pin	VDC	
FP-U1	1	6.0	FP-U2	1	1 to 5	FIL-U1 (2-band board)	3	0.8-1.0	RF-U1	1	1.4	RF-U4	6	6.6	RF-U9	2	6.8	
	2	1.1		3	6.0			4	6.0		2	1.4		7	13.6		3	6.8
	3	6.0		4	6.0			13	5.5		4	4.9		8	6.8		6	6/8
	4	1.8		7	6.0			14	6.0		5	4.9					7	13.6
	5	6.0						15	< 0.3		6	6.0	RF-U7	1	1.4			
	6	2.5	FP-U3	5	6.0			16	< 0.3		7	5.3		2	1.4	RF-Q6	B	1.1
	8	5.6		6	6.0						8	6.0		4	4.8		C	13.6
	9	3.0		8	6.0								5	4.8		E	0.5	
	10	3.0							RF-U2	1	*		6	6.0				
	11	6.0	FP-U5	1, 2, 3	3.0					2	1.4		7	5.3	RF-Q7	B	0.0	
	13	2.3		5	6.0					4	*		8	6.0		C	13.6	
	14	2.8		6	4.8					5	*					E	0.0	
	15-17	3.0		7	4.8					6	6.0	RF-U8	1					
	18	6.0		8	6.0					7	5.4		2					
	19-22	3.0								8	6.0		4					
	23	6.0											5					
	24-30	3.0							RF-U3	1	1.3		6					
	32	6.0								2	*		7					
	33-39	3.0								3	*		8					
	40	6.0								5	4.0							
										6	8.0							
										7	4.0							
										8	1.3							

ELECRAFT K1 QUICK REFERENCE

Tap once to show band,
tap twice to change bands

Hold to select display
mode: normal, S-meter,
or BAT (supply voltage)

LCD

RX: VFO freq or S-meter
TX: bargraph, 1 bar per watt

LEDs

RIT / XIT - GREEN / ORANGE
ATTN - YELLOW

Hold both for TUNE;
during TUNE, can
change power w/WPM+/-

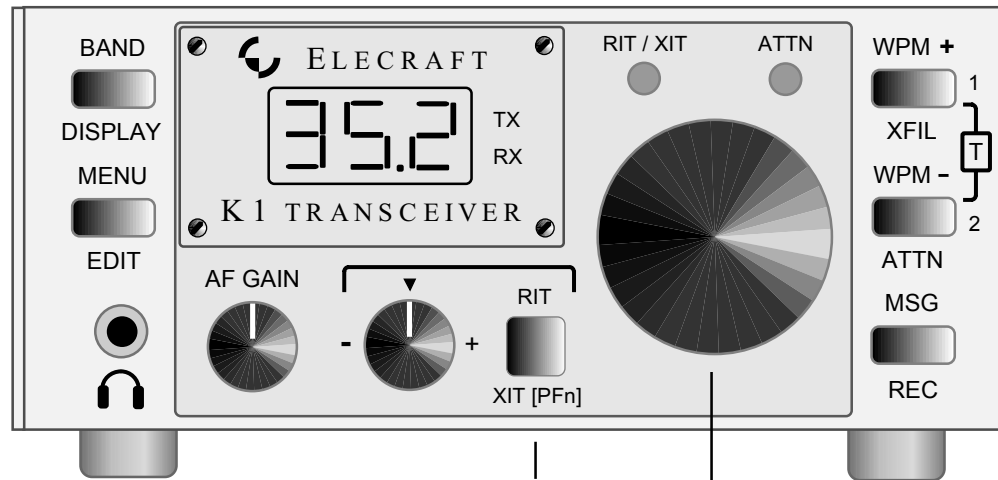

Tap for RIT on/off, hold for XIT on/off
(PFn normally = XIT; see MENU)

VFO

Tap for WPM up,
Hold for FL1/2/3

Tap for WPM down,
Hold for ATTN on/off

Tap to play message 1 or 2,
hold to record message 1 or 2
(when prompted with "1-2"
during message play,
tap 1 or 2 for single play,
hold 1 or 2 for auto-repeat)

MENU

Tap to enter menu, hold to edit; use WPM+/- to scroll menu or modify parameters

OUT	POWER OUTPUT, 0.1-7.0 W (hold DISPLAY to select P=0)	IAB	IAMBIC MODE, A or B	CAL	Operating freq. cal (OPF), per-band; hold DISPLAY for VFO display (OSC)
STL	SIDETONE VOLUME LEVEL, 0-31	AGC	On or Off	SIG	S-METER ZERO SET: Lxx, xx = 30-70 (hold DISPLAY for scale: H x, x = 2-6)
STP	SIDETONE PITCH (Hz) or SPOT	LED	RIT/XIT/ATTN LEDs On or Off	NB	NOISE BLANKER: Off, HIGH, LO
T-R	QSK DELAY, 0 - 900 ms	FLx	XTAL FILTER BW, 200-900 Hz (hold XFIL to select FL1/2/3, then tap WPM +/- to set bandwidth)	ATU	AUTO-TUNER mode (see ATU manual)
RPT	AUTOREPEAT DELAY, 0-255 sec	Bx	BAND ASSIGNMENT, MHz (tap BAND to select B1 or B2; 30m: hold DISPLAY to select 10.0/10.1)	PFn	PROGRAMMABLE FUNCTION; shortcut to selected menu entry, or set to "NOR" (normal) to use as XIT
INP	KEYING DEVICE: Hnd, PDn, PDr				